

Price List of Solar Power Lamps

				
SolarWrap Panel Page 2	Solar Pole street light Page 3-4	All in two solar street light Page 5-7	Solar bollard light Page 8-9	All in one solar garden light Page 10-13
				
All in one solar street light Page 14-16	Solar street with 4G/WIFI camera Page 17-20	All in two solar street light Page 21	Solar WIFI/4G/5G camera Page 22	Solar ceiling/High Bay light Page 23
				
Hybrid Solar Fan with BT Audio Page 24	Solar Tube Light Page 25	UFO Solar garden lamp with App Page 26-27	Solar Garden lamp Page 27	Solar Moon Lamp Page 28
				
Solar Flood light Page 29-35	Solar Flood Light with camera Page 36-38	Solar Power system Page 39-41	Solar Water pump Page 42-43	Hybrid Solar Power System 5KW-12KW with TV Page 44-49

SolarWrap Panel 100W-200W

Product Picture	Model NO.	Module	Package
	G100W	Peak Power : 100W Max.voltage : 18V Max. current : 5.6A Size : 220*228*1160mm	Qty/Carton : 1 Set CTN Size : 125x28x28cm N.W: 16.30Kg G.W: 17.80Kg
	G140W	Peak Power : 140W Max.voltage : 36V Max. current : 7.8A Size : 220*228*1560mm	Qty/Carton : 1 Set CTN Size : 165x28x28cm N.W: 22.70Kg G.W: 24.30Kg
	G200W	Peak Power : 200W Max.voltage : 36V Max. current : 7.8A Size : 220*228*1560mm	Qty/Carton : 1 Set CTN Size : 216x28x28cm N.W: 25.30Kg G.W: 27.80Kg

MPPT controller must be adopted for the vertical PV systems.
36V version applies both 12V and 24V batteries.

Common Specification

- Fixture materials:Alumimium+Glass
- Connection cable : 0.5 meters 2.5mm²
- Powers max : 100W / 140W
- Connection cables : 2 pairs of MC4
- Type of solar panel: rigid solar panel
- Linkable & Disassemble : Yes
- Solar panel cell : Monocrystalline
- Max diameter of pole to suit : 155mm
- Conversion efficiency : 19.50%
- Wind resistance level : Class 13 37.0~41.4m/s
- Qty of slim solar module : 6 pcs/module
- IP Rate :IP65
- Connectors type : MC4 Warranty : 5 years

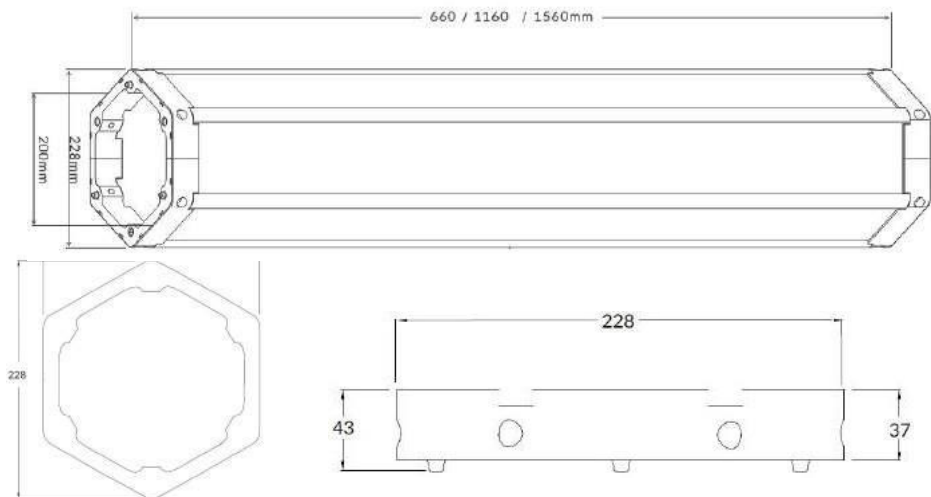



New Solar Wrap Pole street light 30W-120W

Item	Product Picture	Key Specification and components prices		Control System
1		30W Solar Light :	200W Solar Hexagonal :	Automatically ON/OFF with MPPT controller Hybrid type with 220V as backup Wireless Intelligent Control basd on 4G/GPRS Technology
		Model No : EC-U30W Body material : aluminium die cast LED power: 30W LED type : 48nos Philips SMD3030 BECM angle : 140°70° Luminous flux : >4800lm Color temperature : 6000K Battery capacity: 12.8V 307WH Lifetime :> 1800 Cycles Solar controller : MPPT Sensor type : Microwave Charging time : 5 Hours Battery autonomy : 2~4 Days Operating tem. : -20°C ~ 65°C IP rate: IP67 Warranty : 3 YECrs	SolarWrap module no.: G200W PECK power: 200W PECK vol & current :36V 7.78A Module quantity : 1 Pc Soalr cell Type : MONO Module size : 220*228*1560mm Warranty : 5 YECrs Lifetime : > 20 YECrs	
		5M Steel Pole :	5Meters	
Order NO. : EC-M30W				

Item	Product Picture	Key Specification and components prices		Control System
2		50W Solar Light :	280W Solar Hexagonal :	Automatically ON/OFF with MPPT controller Hybrid type with 220V as backup Wireless Intelligent Control basd on 4G/GPRS Technology
		Model No : EC-U50W Body material : aluminium die cast LED power: 50W LED type : 72nos Philips SMD3030 BECM angle : 140°70° Luminous flux : >6800lm Color temperature : 6000K Battery capacity: 12.8V 460WH Lifetime :> 1800 Cycles Solar controller : MPPT Sensor type : Microwave Charging time : 5 Hours Battery autonomy : 2~4 Days Operating tem. : -20°C ~ 65°C IP rate: IP67 Warranty : 3 YECrs	SolarWrap module no.: G140W 2Pcs PECK power: 280W PECK vol & current :18V 15.55A Module quantity : 2 Pcs Module size : 200*228*1560mm Soalr cell Type : MONO Warranty : 5 YECrs Lifetime : > 20 YECrs	
		6M Steel Pole :	6Meters	
Order NO. : EC-M50W				

Item	Product Picture	Key Specification and components prices		Control System
3		60W Solar Light:	Solar Hexagonal :	Automatically ON/OFF with MPPT controller Hybrid type with 220V as backup Wireless Intelligent Control basd on 4G/GPRS Technology
		Model No : EC-T60W Body material : aluminium die cast LED power: 60W LED type : 248nos Philips SMD3030 BECM angle : 145°83° Luminous flux : >7,800lm Color temperature : 6000K Battery capacity: 12.8V 538WH Lifetime :> 2500 Cycles Solar controller : MPPT or Hybrid Controller / Wireless Intelligent Charging time : 5 Hours Battery autonomy : 3~5 Days Operating tem. : -20°C ~ 65°C IP rate: IP67 Warranty : 5 YECrs	SolarWrap module no.: 340W=Q200+Q140 PECK power: 340W PECK vol & current :36V 8.33A Module quantity : 2 Pcs Module size : 220*228*1560mm Soalr cell Type : MONO Warranty : 5 YECrs Lifetime : > 20 YECrs	
		8M Steel Pole :	8Meters	
Order NO. : EC-M60W				

Item	Product Picture	Key Specification and components prices		Control System
4		80W Solar Light HECd	400W Solar Hexagonal :	Automatically ON/OFF with MPPT controller Hybrid type with 220V as backup Wireless Intelligent Control basd on 4G/GPRS Technology
		Model No : EC-T80W Body material : aluminium die cast LED power: 80W LED type : 248nos Philips SMD3030 BECM angle : 145°83° Luminous flux : >12,800lm Color temperature : 6000K Battery capacity: 12.8V 768WH Lifetime :> 2500 Cycles Solar controller : MPPT or Hybrid / Wireless Intelligent Control Charging time : 5 Hours Battery autonomy : 3~5 Days Operating tem. : -20°C ~ 65°C IP rate: IP67 Warranty : 5 YECrs	SolarWrap module no.: 400W=Q200 2pcs PECK power: 400W PECK vol & current :36V 11.67A Module quantity : 3 Pcs Module size : 220*228*1560mm Soalr cell Type : MONO Warranty : 5 YECrs Lifetime : > 20 YECrs	
		8M Steel Pole :	8Meters	
Order NO. : EC-M80W				

Item	Product Picture	Key Specification and components prices 80Watts*2 Dual HECds		Control System
5		80Watts*2 Dual Model No : EC-T80W Body material : aluminium die cast LED power: 80W LED type : 248nos Philips SMD3030 BECm angle : 145*83° Luminous flux : >12,800lm Color temperature : 6000K Battery capacity: 12.8V 768WHX2 Lifetime :> 2500 Cycles Solar controller : MPPT or Hybrid / Wireless Intelligent Control Charging time : 5 Hours Battery autonomy : 3~5 Days Operating tem. : -20°C ~ 65°C IP rate: IP67 Warranty : 5 YECrs	800W Solar Hexagonal : SolarWrap module no.: 800W=Q200 4pcs PECK power: 800W PECK vol & current :36V 11.67A Module quantity : 3 Pcs Module size : 220*228*1560mm Solar cell Type : MONO Warranty : 5 YECrs Lifetime : > 20 YECrs	Automatically ON/OFF with MPPT controller
		12M Steel Pole : Height : 12 Meters Top / Bottom Size: 70mm / 180mm Thickness : 4mm Hot dip galvanized and Powder coated treatment RAL : 7045	Hybrid type with 220V as backup	
		Wireless Intelligent Control based on 4G/GPRS Technology		
Order NO. : EC-M80W2				

Item	Product Picture	Key Specification and components prices		Control System
6		100W Solar Light : Model No : EC-T100W Body material : aluminium die cast LED power: 100W LED type : 248nos Philips SMD3030 BECm angle : 145*83° Luminous flux : >12,800lm Color temperature : 6000K Battery capacity: 25.6V 921WH Lifetime :> 2500 Cycles Solar controller : MPPT or Hybrid / Wireless Intelligent Control Charging time : 5 Hours Battery autonomy : 3~5 Days Operating tem. : -20°C ~ 65°C IP rate: IP67 Warranty : 5 YECrs	500W Solar Hexagonal : SolarWrap module no.: 500W=G200WX2+G100X1 PECK power: 500W PECK vol & current :36V 15.55A Module quantity : 4 Pcs Module size : 220*228*1560mm Solar cell Type : MONO Warranty : 5 YECrs Lifetime : > 20 YECrs	Automatically ON/OFF with MPPT controller
		10M Steel Pole : Height : 10 Meters Top / Bottom Size: 100mm / 230mm Thickness : 4mm Hot dip galvanized and powder coated treatment	Hybrid type with 220V as backup	
		Wireless Intelligent Control based on 4G/GPRS Technology		
Order NO. : EC-M100W				

Item	Product Picture	Key Specification and components prices		Control System
7		120W Solar Light : Model No : EC-T120W Body material : aluminium die cast LED power: 120W LED type : 248nos Philips SMD3030 BECm angle : 145*83° Luminous flux : >12,800lm Color temperature : 6000K Battery capacity: 25.6V 1075WH Lifetime :> 2500 Cycles Solar controller : MPPT or Hybrid / Wireless Intelligent Control Charging time : 5 Hours Battery autonomy : 3~5 Days Operating tem. : -20°C ~ 65°C IP rate: IP67	600W Solar Hexagonal : SolarWrap module no.: 600W=G200WX3 PECK power: 600W PECK vol & current :36V 15.55A Module quantity : 4 Pcs Module size : 220*228*1560mm Solar cell Type : MONO Warranty : 5 YECrs Lifetime : > 20 YECrs	Automatically ON/OFF with MPPT controller
		10M Steel Pole : Height : 10 Meters Top / Bottom Size: 100mm / 230mm Thickness : 4mm Hot dip galvanized and powder coated treatment	Hybrid type with 220V as backup	
		Wireless Intelligent Control based on 4G/GPRS Technology		
Order NO. : EC-M120W				

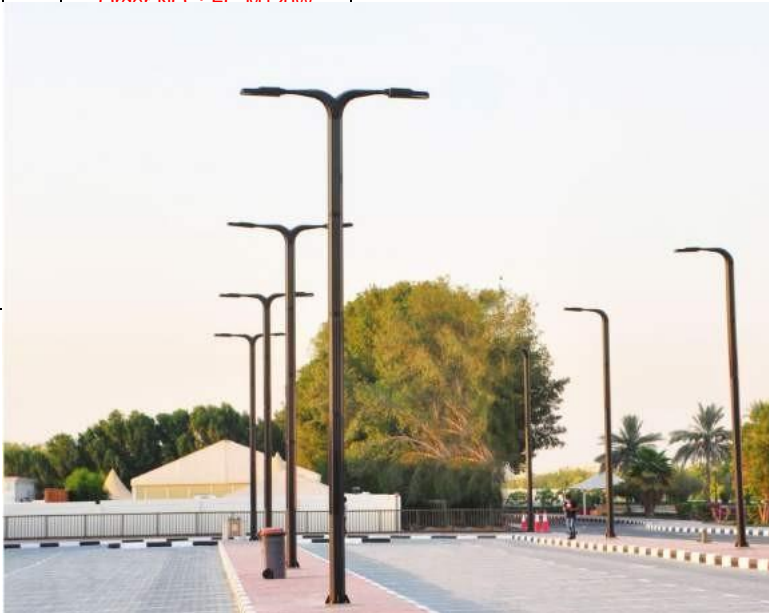



Price list of All in two Solar street light 30W-120W

Item	Product Picture	Key Specification and components prices	Control System	
1		30W Solar Light : Model No : EC-U30W Body material : aluminium die cast LED power: 30W LED type : 48nos Philips SMD3030 BECM angle : 140°70° Luminous flux : >4800lm Color temperature : 6000K Battery capacity: 12.8V 307WH Lifetime :> 1800 Cycles Solar controller : MPPT Sensor type : Microwave Charging time : 5 Hours Battery autonomy : 2-4 Days Operating tem. : -20°C ~ 65°C IP rate: IP67 Warranty : 3 YECrs	70W Mono Solar Panel : Regular mono solar panel.: 70W PECK power: 70W PECK vol & current :18V 7.78A Module quantity : 1 Pc Soalr cell Type : MONO Module size : 81x20x75 cm Warranty : 5 YECrs Lifetime : > 20 YECrs	Automatically ON/OFF with MPPT controller
			5M Steel Pole : Height : 5 Meters Pole Size: 105mm Thickness : 3mm Hot dip galvanized and Podwer coated trECtment RAL : 7045	Hybrid type with 220V as backup
				Wireless Intelligent Control basd on 4G/GPRS Technology
Order NO. : EC-A30W				

Item	Product Picture	Key Specification and components prices	Control System	
2		50W Solar Light : Model No : EC-U50W Body material : aluminium die cast LED power: 50W LED type : 72nos Philips SMD3030 BECM angle : 140°70° Luminous flux : >6800lm Color temperature : 6000K Battery capacity: 12.8V 460WH Lifetime :> 1800 Cycles Solar controller : MPPT Sensor type : Microwave Charging time : 5 Hours Battery autonomy : 2-4 Days Operating tem. : -20°C ~ 65°C IP rate: IP67 Warranty : 3 YECrs	100W Mono Solar Panel: Regular mono solar panel.: 100W PECK power: 100W PECK vol & current :18V 15.55A Module quantity : 1Pcs Module size : 111x15x73cm Soalr cell Type : MONO Warranty : 5 YECrs Lifetime : > 20 YECrs	Automatically ON/OFF with MPPT controller
			6M Steel Pole : Height : 6 Meters Pole Size: 105mm Thickness : 3mm Hot dip galvanized and Podwer coated trECtment RAL : 7045	Hybrid type with 220V as backup
				Wireless Intelligent Control basd on 4G/GPRS Technology
Order NO. : EC-A50W				

Item	Product Picture	Key Specification and components prices	Control System	
3		60W Solar Light: Model No : EC-T60W Body material : aluminium die cast LED power: 60W LED type : 248nos Philips SMD3030 BECM angle : 145°83° Luminous flux : >7,800lm Color temperature : 6000K Battery capacity: 12.8V 538WH Lifetime :> 2500 Cycles Solar controller : MPPT or Hybrid Controller / Wireless Intelligent Charging time : 5 Hours Battery autonomy : 3-5 Days Operating tem. : -20°C ~ 65°C IP rate: IP67 Warranty : 5 YECrs	120W Mono Solar Panel : Regular mono solar panel.: 120W PECK power: 120W PECK vol & current :36V 8.33A Module quantity : 1Pcs Module size : 220*228*1560mm Soalr cell Type : MONO Warranty : 5 YECrs Lifetime : > 20 YECrs	Automatically ON/OFF with MPPT controller
			8M Steel Pole : Height : 8 Meters Top / Bottom Size: 70mm / 105mm Thickness : 3.5mm Hot dip galvanized and Podwer coated trECtment RAL : 7045	Hybrid type with 220V as backup
				Wireless Intelligent Control basd on 4G/GPRS Technology
Order NO. : EC-A60W				

Item	Product Picture	Key Specification and components prices	Control System	
4	 <p>Order NO. : EC-A80W</p>	80W Solar Light HECd Model No : EC-T80W Body material : aluminium die cast LED power: 80W LED type : 248nos Philips SMD3030 BECM angle : 145°83° Luminous flux : >12,800lm Color temperature : 6000K Battery capacity: 12.8V 768WH Lifetime :> 2500 Cycles Solar controller : MPPT or Hybrid / Wireless Intelligent Control Charging time : 5 Hours Battery autonomy : 3~5 Days Operating tem. : -20°C ~ 65°C IP rate: IP67 Warranty : 5 YECrs	150W Mono Solar Panel : Regular mono solar panel.: 150W PECK power: 150W PECK vol & current :36V 11.67A Module quantity : 1 Pcs Module size : 155x34x73cm Soalr cell Type : MONO Warranty : 5 YECrs Lifetime : > 20 YECrs 8M Steel Pole : Height : 8 Meters Top / Bottom Size: 70mm / 105mm Thickness : 4mm Hot dip galvanized and Podwer coated trECtment RAL : 7045	Automatically ON/OFF with MPPT controller Hybrid type with 220V as backup Wireless Intelligent Control basd on 4G/GPRS Technology

Item	Product Picture	Key Specification and components prices 80Watts*2 Dual HECds	Control System	
5	 <p>Order NO. : EC-A80W2</p>	80Watts*2 Dual Model No : EC-T80W Body material : aluminium die cast LED power: 80W LED type : 248nos Philips SMD3030 BECM angle : 145°83° Luminous flux : >12,800lm Color temperature : 6000K Battery capacity: 12.8V 768WH Lifetime :> 2500 Cycles Solar controller : MPPT or Hybrid / Wireless Intelligent Control Charging time : 5 Hours Battery autonomy : 3~5 Days Operating tem. : -20°C ~ 65°C IP rate: IP67 Warranty : 5 YECrs	300W Mono Solar Panel: Regular mono solar panel.: 150Wx2pcs PECK power: 150W PECK vol & current :36V 11.67A Module quantity : 2 Pcs Module size : 155x34x73cm Soalr cell Type : MONO Warranty : 5 YECrs Lifetime : > 20 YECrs 12M Steel Pole : Height : 12 Meters Top / Bottom Size: 70mm / 115mm Thickness : 4mm Hot dip galvanized and Podwer coated trECtment RAL : 7045	Automatically ON/OFF with MPPT controller Hybrid type with 220V as backup Wireless Intelligent Control basd on 4G/GPRS Technology

Item	Product Picture	Key Specification and components prices	Control System	
6	 <p>Order NO. : EC-A100W</p>	100W Solar Light : Model No : EC-T100W Body material : aluminium die cast LED power: 100W LED type : 248nos Philips SMD3030 BECM angle : 145°83° Luminous flux : >12,800lm Color temperature : 6000K Battery capacity: 25.6V 921WH Lifetime :> 2500 Cycles Solar controller : MPPT or Hybrid / Wireless Intelligent Control Charging time : 5 Hours Battery autonomy : 3~5 Days Operating tem. : -20°C ~ 65°C IP rate: IP67 Warranty : 5 YECrs	200W Mono Solar Panel: Regular mono solar panel.: 200W PECK power: 200W PECK vol & current :36V 15.55A Module quantity : 1 Pcs Module size : 129°7*101cm Soalr cell Type : MONO Warranty : 5 YECrs Lifetime : > 20 YECrs 10M Steel Pole : Height : 10 Meters Top / Bottom Size: 100mm / 200mm Thickness : 4mm Hot dip galvanized and podwer coated trECtment	Automatically ON/OFF with MPPT controller Hybrid type with 220V as backup Wireless Intelligent Control basd on 4G/GPRS Technology

Item	Product Picture	Key Specification and components prices	Control System	
7	 <p>Order NO. : EC-A120W</p>	120W Solar Light : Model No : EC-T120W Body material : aluminium die cast LED power: 120W LED type : 248nos Philips SMD3030 BECM angle : 145°83° Luminous flux : >12,800lm Color temperature : 6000K Battery capacity: 25.6V 1075WH Lifetime :> 2500 Cycles Solar controller : MPPT or Hybrid / Wireless Intelligent Control Charging time : 5 Hours Battery autonomy : 3~5 Days Operating tem. : -20°C ~ 65°C IP rate: IP67 Warranty : 5 YECrs	260W Mono Solar Panel : Regular mono solar panel.: 260 PECK power: 260W PECK vol & current :36V 15.55A Module quantity : 1Pcs Module size : Soalr cell Type : MONO Warranty : 5 YECrs Lifetime : > 20 YECrs 10M Steel Pole : Height : 10 Meters Top / Bottom Size: 100mm / 200mm Thickness : 4mm Hot dip galvanized and podwer coated trECtment	Automatically ON/OFF with MPPT controller Hybrid type with 220V as backup Wireless Intelligent Control basd on 4G/GPRS Technology

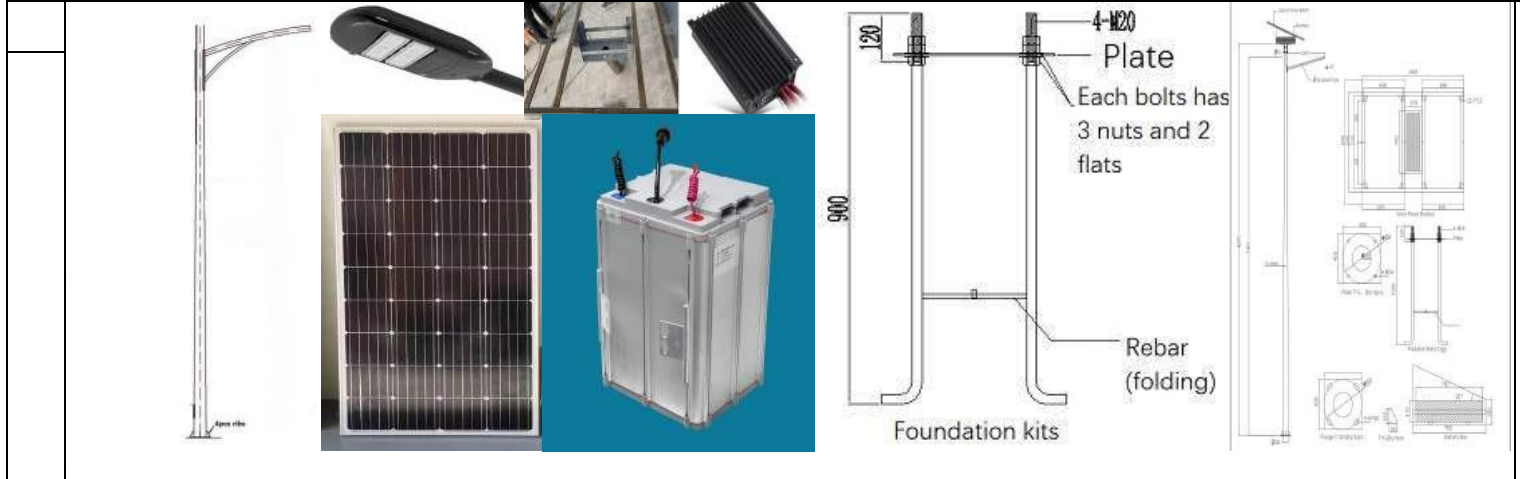

Item	Product Picture	Key Specification and components prices	Control System	
8		100W Solar Light : Model No : 100W Body material : aluminium die cast LED power: 100W LED type : 248nos Philips SMD3030 BECM angle : 145°83° Luminous flux : >16000lm Color temperature : 6000K Battery capacity: 150AH/25.6V Lifetime :> 2500 Cycles Solar controller : MPPT or Hybrid / Wireless Intelligent Control Charging time : 5 Hours Battery autonomy : 3-5 Days Operating tem. : -20°C ~ 65°C IP rate: IP67 Warranty : 5 YECrs	330W Mono Solar Panel : Regular mono solar panel.: 330W PECK power: 330W PECK vol & current :36V 15.55A Module quantity : 1Pcs Module size : Soalr cell Type : MONO Warranty : 5 YECrs Lifetime : > 20 YECrs	Automatically ON/OFF with MPPT controller
		8M Steel Pole : Height : 8 Meters Top / Bottom Size: 100mm / 200mm Thickness : 4mm Hot dip galvanized and powder coated trECTment	Hybrid type with 220V as backup	
		Order NO. : EC-B100W	Wireless Intelligent Control basd on 4G/GPRS Technology	

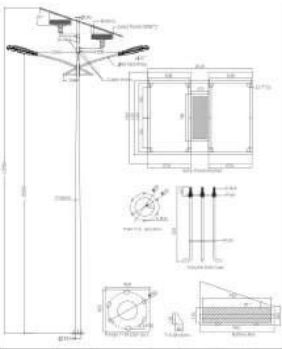





Double Arm solar street lamp 80W					
9		80W Solar Light : Model No : 80W Body material : aluminium die cast LED power: 80W LED type : 248nos Philips SMD3030 BECM angle : 145°83° Luminous flux : >12800lm Color temperature : 6000K Battery capacity: 100AH/25.6V Lifetime :> 2500 Cycles Solar controller : MPPT or Hybrid / Wireless Intelligent Control Charging time : 5 Hours Battery autonomy : 3-5 Days Operating tem. : -20°C ~ 65°C IP rate: IP67 Warranty : 5 YECrs	2X80W head led	400W Mono Solar Panel : Regular mono solar panel.: 200WX2 PECK power: 400W PECK vol & current :36V 15.55A Module quantity : 1Pcs Module size : Soalr cell Type : MONO Warranty : 5 YECrs Lifetime : > 20 YECrs	Automatically ON/OFF with MPPT controller
		10M Steel Pole : Height : 10 Meters Top / Bottom Size: 100mm / 200mm Thickness : 4mm Hot dip galvanized and powder coated trECTment	Hybrid type with 220V as backup		
		Order NO. : EC-B80WX2	Wireless Intelligent Control basd on 4G/GPRS Technology		



Solar LED Lights for Garden

Item	Products Picture	Key Specification	White Switchable by button	Models & Exw Price (US\$)						
ARKO AI-GL260R		Dome material : Polycarbonate Light bulb size : φ260mm LED : 1.5W > 220lm (CCT 6000K) Solar Panel : 6.2W 5V MONO CCT : White / RGBCW Changeable Battery : LifePO4 3.2V 12AH Battery lifetime : > 2000 cycles Body color : Black / Gray Warranty : 2 years IK10-Vandal Resistant	6000k	4000k	3000k	Order number	GL260R-38S	GL260R-60S	GL260R-90S	GL260R--WS
			Color Adjustable by Remote			Models & Exw Price (US\$)				
						Order number	GL260R-38R	GL260R-60R	GL260R-90R	GL260R-WR
			Light Height	38CM	60CM	90CM	Wall mounted			

Item	Products Picture	Key Specification	White Switchable by button	Models & Exw Price (US\$)						
ARES AI-GL255R		Material : PC+Aluminium Alloy Light bulb size : φ255mm LED : 1.5W > 220lm (CCT 6000K) Solar Panel : 6.2W 5V MONO CCT : White / RGBCW Changeable Battery : LifePO4 3.2V 12AH Battery lifetime : > 2000 cycles IP Grade : IP65 Body color : Black / Gray Warranty : 2 years	6000k	4000k	3000k	Order number	GL255R-38S	GL255R-60S	GL255R-90S	GL255R--WS
			Color Adjustable by Remote			Models & Exw Price (US\$)				
						Order number	GL255R-38R	GL255R-60R	GL255R-90R	GL255R-WR
			Light Height	38CM	60CM	90CM	Wall mounted			

Item	Products Picture	Key Specification	White Switchable by button	Models & Exw Price (US\$)						
HADES AI-GL255S		Material : Polycarbonate +Aluminium Alloy Light bulb size : 255*255mm LED : 2.5W > 300lm (CCT 6000K) Solar Panel : 9.2W 5V MONO CCT : White / RGBCW Changeable Battery : LifePO4 3.2V 12AH Battery lifetime : > 2000 cycles IP Grade : IP65 Body color : Black / Gray Warranty : 2 years	6000k	4000k	3000k	Order number	GL255S-38S	GL255S-60S	GL255S-90S	GL255S--WS
			Color Adjustable by Remote			Models & Exw Price (US\$)				
						Order number	GL255S-38R	GL255S-60R	GL255S-90R	GL255S-WR
			Light Height	38CM	60CM	90CM	Wall mounted			



Item	Light Picture	Key Specification
2.4G Remote Control		One remote can control all these lights with in 25 meters in open air place. We suggest you to buy 1 remote control for every 5 pieces of RGBCW solar lights. Order number: 2.4G-REMOTE

Motion Sensor Function	
Motion sensor function is optional in order to save battery energy, to be used for the regions where sunshine is weak especially in winter. 30%+100% when sensor is triggered for all night operation.	

- Remark**
- Prices are based on EXW Zhuhai China..
 - Two years warranty
 - 3 - 7 days for samples, 15-25 days for bulk order.
 - The solar light head and aluminium pillar can be packed separately to reduce shipping cost. Can be mounted easily with screws. Suitable for DIY.













Solar Power Ballard Lamps

Picture	Model	Description	Diameter	Height	Unit Packing(cm)	arton Packing(cm)	Unit weight	Carton weigh	QTY/CTN
	EC-BL01	Material: Aluminium Height: *** Solar panel: 4.2W Battery::5200MA LED: 3W Continuous working time: 13 Hours	23CM	28CM	26.5*26.5*34	81.5*55*36	1.3	8.5	6
			23CM	60CM	26.5*26.5*64	81.5*55*66	1.9	12.5	6
			23CM	80CM	26.5*26.5*86	81.5*55*88	2.1	14	6
			23CM	100CM	26.5*26.5*106	81.5*55*108	2.3	15.5	6
	EC-BL02	Material: Aluminium Height: *** Solar panel: 4.2W Battery:5200MA LED: 3W Continuous working time: 13 Hours Protect Level: IP65	23CM	22CM	26.5*26.5*26	81.5*55*28	1.3	8.5	6
	EC-BL03	Material: Aluminium Height:30CM Solar panel: 4.2W Battery:5200MA LED: 3W Continuous working time: 13 Hours Protect Level: IP65	23CM	30CM	26.5*26.5*34	81.5*55*36	1.5	9	6





ABS Solar Street lamp

Model	Power	Picture	Specification
EC-PS-180W	180W		Lamp Size : 62.2*22.7cm Solar panels: Poly 6V13w Battery: lithium iron phosphate battery 3.2V 18000mAh Patch beads: color temperature 6500k Material: ABS+PC Waterproof grade: IP65 Charging time: 4-6H Lighting time: 8-12 hours of Sustainable Lighting Exposure area: about 100 square meters QTY/CTN:5 PCS Induction:(People come 100% bright, people go 10% bright)
EC-PS-300W	300W		Lamp Size : 72*35.5cm Solar panels: polycrystalline 6V30w Battery: lithium iron phosphate battery 3.2V 36000mAh Patch beads: 162pcs 2835, color temperature 6500k Material: ABS+PC Waterproof grade: IP65 Charging time: 4-6H Lighting time: 8-12 hours of Sustainable Lighting Exposure area: about 150-200 square meters QTY/CTN:4PCS Carton Size:74*34*44.5cm Induction:(People come 100% bright, people go 10% bright)
EC-PS-300W	300W		Lamp Size : 72*35.5cm Solar panels: polycrystalline 6V30w Battery: lithium iron phosphate battery 3.2V 36000mAh Patch beads: 144pcs 3030, color temperature 6500k Material: ABS+PC Waterproof grade: IP65 Charging time: 4-6H Lighting time: 8-12 hours of Sustainable Lighting Exposure area: about 150-200 square meters QTY/CTN:4PCS Carton Size: 74*34*44.5cm Induction:(People come 100% bright, people go 10% bright)
EC-YL-60W	60W		Solar panels: Mono 6V25w Battery: lithium iron phosphate battery 3.2V 24000mAh Patch beads: Changfang brand 5730 Model 60 LENS beads, color temperature 6500k Material: Die Cast Aluminum Waterproof grade: IP67 Charging time: 4-6H Lighting time: 10-15 hours of Sustainable Lighting Exposure area: about 100 square meters Control mode: remote control and light control Packing Number: 1sets/boxes Installation mode: wall mounting Suggested installation height: 4-5 meters Product standard: lamp head 1 + wall screw 1 + remote controller 1
EC-YL-100W	100W		Solar panels: Mono 6V30w Battery: lithium iron phosphate battery 3.2V 30000mAh Patch beads: Changfang brand 5730 Model 100 LENS beads, color temperature 6500k Material: Die Cast Aluminum Waterproof grade: IP67 Charging time: 4-6H Lighting time: 10-15 hours of Sustainable Lighting Exposure area: about 100 square meters Control mode: remote control and light control Packing Number: 1sets/boxes Installation mode: wall mounting Suggested installation height: 4-5 meters Product standard: lamp head 1 + wall screw 1 + remote controller 1
EC-YL-180W	180W		Solar panels: Mono 6V35w Battery: lithium iron phosphate battery 3.2V 36000mAh Patch beads: Changfang brand 5730 Model 180 LENS beads, color temperature 6500k Material: Die Cast Aluminum Waterproof grade: IP67 Charging time: 4-6H Lighting time: 10-15 hours of Sustainable Lighting Exposure area: about 200 square meters Control mode: remote control and light control Packing Number: 1sets/boxes Installation mode: wall mounting Suggested installation height: 4-5 meters Product standard: lamp head 1 + wall screw 1 + remote controller 1



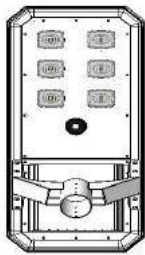
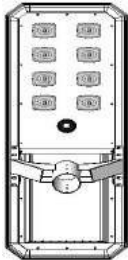
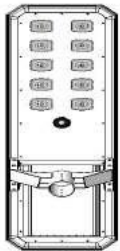
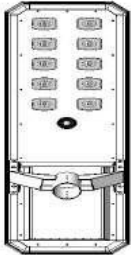

ABS-300W			<p>Solar panels: Monocrystalline silicon 6V40w Battery: lithium iron phosphate battery 3.2V 36000mAh Patch beads: Changfang brand 3030 Model 306 beads, color temperature 6500k Material: aluminum Waterproof grade: IP67 Charging time: 4-6H Lighting time: 12-15 hours of Sustainable Lighting Exposure area: about 150 square meters Control mode: remote control and light control Packing Number: 1 sets/boxes</p>
ABS-400W			<p>Solar panels: Monocrystalline silicon 6V50w Battery: lithium iron phosphate battery 3.2V 48000mAh Patch beads: Changfang brand 3030 Model 408 beads, color temperature 6500k Material: aluminum Waterproof grade: IP67 Charging time: 4-6H Lighting time: 12-15 hours of Sustainable Lighting Exposure area: about 200 square meters Control mode: remote control and light control Packing Number: 1 sets/boxes</p>
ABS-500W			<p>Solar panels: Monocrystalline silicon 6V60w Battery: lithium iron phosphate battery 3.2V 60000mAh Patch beads: Changfang brand 3030 Model 510 beads, color temperature 6500k Material: aluminum Waterproof grade: IP67 Charging time: 4-6H Lighting time: 12-15 hours of Sustainable Lighting Exposure area: about 300 square meters Control mode: remote control and light control Packing Number: 1 sets/boxes</p>
EC-SD-100	100W		<p>Name: All in two solar street light 100W Model: SD-100 Power: 100W Polycrystalline Silicon (12v/25W) LED: SMD2835 196PCS, Φ: 60mm/W Waterproof level: IP65 Lithium iron phosphate battery: 6.4V20Ah Charging time: 5H Lighting time: sustainable lighting 16H Light body size: 495*210*40mm Lighting area: 150 square metres Solar panel size: 530*370*17mm 1. Light control (lights on at night, lights out during the day) 2. Light control + timing remote control (remote control switch)</p>
EC-SD-400W	400W		<p>Solar Panel: Polycrystalline 40w Solar Panel Size: 67*44.5cm Battery: LiFePO4 battery 3.2V 48AH Beading: Rectangular brand 2835 model 1014 beads, color temperature 6500k Material: Aluminum + Glass Waterproof Grade: IP67 Charging time: 4-6H Lighting time: 12-15 hours of continuous lighting Exposure area: about 300 square meters Control method: remote control and light control Packaging Quantity: 1 set/box Color box packaging 9.6Kg Box size: 71*48*17cm</p>

integrated solar street lamp (htslg)







Item No.	LED Power	Image	Description	Packing
AL2-30W	30W		Light Power:30W Solar panel: MONO 18V60w Battery: Lithium iron phosphate battery 3.2V 4000mah SMD lamp beads:54pieces of 3030 large lamp beads. Charge time:6-8H Discharge time:12-15hours Color temperature: 6500k-7500k Material: Aluminum profile Waterproof rating: IP65 Working model:Light-Induction & Remote control	Light Size:878*386*81mm Packing:2pcs/ctn
V22-40W	40W		Light Power:40W Solar panel: MONO 18V70w Battery: Lithium iron phosphate battery 3.2V 5000mah SMD lamp beads:72pieces of 3030 large lamp beads. Charge time:6-8H Discharge time:12-15hours Color temperature: 6500k-7500k Material: Aluminum profile Waterproof rating: IP65 Working model:Light-Induction & Remote control	Light size:1118*386*81mm Packing:2pcs/CTN
V22-50W	50W		Light Power:50W Solar panel: MONO 18V80w Battery: Lithium iron phosphate battery 3.2V 6000mah SMD lamp beads:90pieces of 3030 large lamp beads. Charge time:6-8H Discharge time:12-15hours Color temperature: 6500k-7500k Material: Aluminum profile Waterproof rating: IP65 Working model:Light-Induction & Remote control	Light size:1323*386*81mm Packing:2pcs/CTN
V22-60W	60W		Light Power:60W Solar panel: MONO 18V90w Battery: Lithium iron phosphate battery 3.2V 7000mah SMD lamp beads:108pieces of 3030 large lamp beads. Charge time:6-8H Discharge time:12-15hours Color temperature: 6500k-7500k Material: Aluminum profile Waterproof rating: IP65 Working model:Light-Induction & Remote control	Light size:1428*386*81mm Packing:2pcs/CTN
V22-70W	70W		Light Power:70W Solar panel: MONO 18V100w Battery: Lithium iron phosphate battery 3.2V 8000mah SMD lamp beads:126pieces of 3030 large lamp beads. Charge time:6-8H Discharge time:12-15hours Color temperature: 6500k-7500k Material: Aluminum profile Waterproof rating: IP65 Working model:Light-Induction & Remote control	Light size:1598*386*81mm Packing:2pcs/CTN

AL-A-FLS-60W	60W		<p>Energy board: MONO 18V66w Battery: Lithium iron phosphate battery 3.2V 6000mah SMD lamp beads:90 pieces of 3030 large lamp beads , color temperature 6500k Material: Aluminum profile Waterproof rating: IP65 Irradiation area: about 200 square meters Control mode: light control, manual switch</p>	<p>Product/Packing Size: 326*241*60mm/395*345 *120mm Net/Gross Weight:2.5/3KGS Packing: 1 set/carton Loading plan: 1530 sets/20'GP 3180 sets/40'HC</p>
AL-B-FLS-60W	60W		<p>Energy board: MONO 18V66w Battery: Lithium iron phosphate battery 3.2V 6000mah SMD lamp beads:90 pieces of 3030 large lamp beads , color temperature 6500k Material: Aluminum profile Waterproof rating: IP65 Irradiation area: about 200 square meters Control mode: light control, manual switch</p>	<p>Product/Packing Size: 495*355*80mm/570*390 *150mm Net/Gross Weight:5.5/6.3KGS Packing: 1 set/carton Loading plan: 800 sets/20'GP 1600 sets/40'HC</p>
AL-01-300W	300W		<p>Lamp size:1076*355mm solar panel: Mono 6V 63w Battery: lithium iron phosphate Battery 3.2V 50Ah Lamp beads: 3pcs COB light source Color temperature 6500k Material: Aluminium+glasses Waterproof level: IP65 Charging time: 4-6H Lighting Time: 8-12 hours Exposure area: about 100 square meters QTY/Carton: 1PCS</p>	<p>Product/Packing Size: 1076*355*80mm/1076*390*150mm Net/Gross Weight:5.5/6.3KGS Packing: 1 set/carton Loading plan: 800 sets/20'GP 1600 sets/40'HC</p>
AL-02-300W	300W		<p>Lamp size:1076*355mm solar panel: Mono 6V 63w Battery: lithium iron phosphate Battery 3.2V 50Ah Lamp beads: 90pcs lens light source Color temperature 6500k Material: Aluminium+glasses Waterproof level: IP65 Charging time: 4-6H Lighting Time: 8-12 hours Exposure area: about 100 square meters QTY/Carton: 1PCS</p>	<p>Product/Packing Size: 495*355*80mm/570*390 *150mm Net/Gross Weight:5.5/6.3KGS Packing: 1 set/carton Loading plan: 800 sets/20'GP 1600 sets/40'HC</p>

Price List of TEKO All in One Solar LED Street Light (For Residential Use)

Solar Light Fixture	Model NO.	Specification	Lighting Program	Package
	AI-T120	Light fixture size : 410*200*70mm Housing material:Aluminium die casting Max power of led chip : 12W LED Chip: SMD5730 240pcs Lumen Flux :>1,200lm LifePo4 Battery Capacity : 3.2V 12000mAh Solar Panel: 12W 5V MONO Sensor:PIR sensor IP rate: IP65 Installation size:φ50-60mm MOQ--100pcs	30% when no sensor + 100% when sensor is triggered for 12 hours. all night operation.	Color Box : 54*26*7.5cm Qty/Carton : 5 Sets Carton Size : 56*42*28cm
	AI-T150	Light fixture size : 560*265*70mm Housing material:Aluminium die casting Max power of led chip : 20W LED Chip: SMD5730 600pcs Lumen Flux :2,000lm (6000K 100% Power) LifePo4 Battery Capacity : 3.2V 18000mAh Solar Panel: 20W 5V MONO Sensor: PIR sensor IP rate: IP65 Installation size:φ50-60mm MOQ--100pcs	30% when no sensor + 100% when sensor is triggered for 12 hours. all night operation.	Color Box : 65*28*8.5cm Qty/Carton :5 Sets Carton Size : 67*47*30cm
	AI-T200	Light fixture size : 690*290*70mm Housing material:Aluminium die casting Max power of led chip : 30W LED Chip: SMD5730 700pcs Lumen Flux :3,000lm (6000K 100% Power) Equal to halogen light:200W LifePo4 Battery Capacity : 3.2V 24000mAh Solar Panel: 30W 5V MONO Sensor : PIR sensor IP rate: IP65 Installation size:φ50-60mm MOQ--100pcs	30% when no sensor + 100% when sensor is triggered for 12 hours. all night operation.	Color Box : 79*30*8.5cm Qty/Carton : 5 Sets Carton Size : 81*32*47cm
Solar Light Fixture	Model NO.	Specification	Lighting Program	Package
	AI-T300	Light fixture size : 660*368*145mm Housing material:Aluminium die casting Lumen Flux :>3,600lm (6000K 100% Power) Practical LED Power : 20Watts max Lithium Battery Capacity : 22AH 12V Solar Panel: 42W MONO Sensor: PIR sensor Installation size:φ60mm or φ70mm 3-5 meters pole	30% when no sensor + 100% when sensor is triggered for 12 hours. all night operation.	Carton Size :74*22*44 cm Qty/Carton : 1 Set
	AI-T400	Light fixture size : 790*368*145mm Housing material:Aluminium die casting Lumen Flux :>4,500lm (6000K 100% Power) Practical LED Power : 30Watts max Lithium Battery Capacity : 30.8AH 12V Solar Panel: 56W MONO Sensor: PIR sensor IP rate: IP65 Installation size:φ60mm or φ70mm 4-6 meters pole	30% when no sensor + 100% when sensor is triggered for 12 hours. all night operation.	Carton Size :86*22*44 cm Qty/Carton : 1 Set
	AI-T600	Light fixture size :1010*430*145mm Housing material:Aluminium die casting Practical LED Power : 45Watts max Lumen Flux :>6,000lm (6000K 100% Power) Lithium Battery Capacity : 40AH 12V Solar Panel: 80W MONO Sensor: PIR sensor IP rate: IP65 Installation size:φ60mm or φ70mm 6-8 meters pole	30% when no sensor + 100% when sensor is triggered for 12 hours. all night operation.	Carton Size :109*24*49 cm Qty/Carton : 1 Set
	AI-T800	Light fixture size :1200*505*160mm Housing material:Aluminium die casting Practical LED Power : 60Watts max Lumen Flux :>8,800lm (6000K 100% Power) Lithium Battery Capacity : 54AH 12.8V Solar Panel: 120W MONO Sensor: PIR sensor IP rate: IP65 Installation size:φ60mm or φ70mm 8-12 meters pole	30% when no sensor + 100% when sensor is triggered for 12 hours. all night operation.	Carton Size :128*24*56 cm Qty/Carton : 1 Set









Price List of AROO All in One Solar LED Street Light (For Commercial Project)

Solar Light Fixture	Model NO.	Specification	Lighting Program	Package
	AIO-30W	Light fixture size : 820*330*140mm Housing material:Aluminium die casting Max power of led chip : 30W max Lumen Flux :3,600lm (6000K 100% Power) LED Quantity : SMD3030 48pcs LifePo4 Battery Capacity : 12.8V 24AH Solar Panel: 45W 18V MONO Sensor : Microwave sensor / PIR sensor Installation size:φ60~75mm Installation height(suggestion):4 ~ 7 meters IP rate: IP65 Warranty : 5 years	30% when no sensor + 100% when sensor is triggered for 12 hours. all night operation.	Packing Size: 900*400*220mm N. W/G.W : 9.80/11.20KGS
	AIO-40W	Light fixture size :1010x340x45mm Housing material:Aluminium die casting Max power of led chip : 40W max Lumen Flux :4,800lm (6000K 100% Power) LED Quantity : SMD3030 96pcs LifePo4 Battery Capacity : 12.8V 30AH Solar Panel: 60W 18V MONO Sensor: Microwave sensor / PIR sensor Installation size:φ60~75mm Installation height(suggestion):4 ~ 7 meters IP rate: IP65 Warranty : 5 years	30% when no sensor + 100% when sensor is triggered for 12 hours. all night operation.	Packing Size: 1100*390*200mm N. W/G.W :12.51/14KGS Packing: 1 set/carton Loading plan: 270 sets/20'GP 550 sets/40'HC
	AIO-50W	Light fixture size : 1070*460*50mm Housing material:Aluminium die casting Max power of led chip : 50W max Lumen Flux :6,000lm (6000K 100% Power) LED Quantity : SMD5050 84pcs LifePo4 Battery Capacity : 12.8V 42AH Solar Panel: 70W 18V MONO Sensor: Microwave sensor / PIR sensor Installation size:φ60~75mm Installation height(suggestion):4 ~ 7 meters IP rate: IP65 Warranty : 5 years	30% when no sensor + 100% when sensor is triggered for 12 hours. all night operation.	Packing Size: 1180*520*200mm N. W/G.W :15.80/17.50KGS Packing: 1 set/carton Loading plan: 270 sets/20'GP 550 sets/40'HC
	AIO-60W	Light fixture size : 1070*460*50mm Housing material:Aluminium die casting Max power of led chip : 60W max Lumen Flux :7,200lm (6000K 100% Power) LED Quantity : SMD5050 84pcs LifePo4 Battery Capacity : 12.8V 54AH Solar Panel: 82W 18V MONO Sensor: PIR sensor Installation size:φ60~75mm Installation height(suggestion):4 ~ 7 meters IP rate: IP65 Warranty : 5 years	30% when no sensor + 100% when sensor is triggered for 12 hours. all night operation.	Packing Size: 1200*510*200mm Net/Gross Weight:18/21KGS Packing: 1 set/carton Loading plan: 270 sets/20'GP 550 sets/40'HC
	AIO-80W	Light fixture size : 1210*460*50mm Housing material:Aluminium die casting Max power of led chip : 80W max Lumen Flux :9,600lm (6000K 100% Power) LED Quantity : SMD5050 84pcs LifePo4 Battery Capacity : 12.8V 60AH Solar Panel: 100W 18V MONO Sensor: PIR sensor Installation size:φ60~75mm Installation height(suggestion):4 ~ 7 meters IP rate: IP65 Warranty : 5 years	30% when no sensor + 100% when sensor is triggered for 12 hours. all night operation.	Packing Size: :1350*510*200mm Net/Gross Weight:21/24KGS Packing: 1 set/carton Loading plan: 270 sets/20'GP 550 sets/40'HC
	AIO-100W	Light fixture size : 1570*460*50mm Housing material:Aluminium die casting LED chip rated power: 100W max Max power of led chip : :12,200lm (6000K 100% Power) LED Quantity : SMD5050 120pcs LifePo4 Battery Capacity : 25.6V 36AH Solar Panel: 120W 36V MONO Sensor: PIR sensor Working temperature:-15°C~ +70°C Installation size:φ50~60mm Installation height(suggestion):5 ~ 8 meters IP rate: IP65 Warranty : 5 years	30% when no sensor + 100% when sensor is triggered for 12 hours. all night operation.	Packing Size: #1: 1660*550*150mm #2: 400*330*230mm Net/Gross Weight:27/33KGS Packing: 1 set/2carton
	AIO-120W	Light fixture size : 1670*460*50mm Housing material:Aluminium die casting Max power of led chip : 120W max Lumen Flux :13,800lm (6000K 100% Power) LED Quantity : SMD5050 120pcs LifePo4 Battery Capacity : 25.6V 42AH Solar Panel: 140W 36V MONO Sensor: PIR sensor Working temperature:-15°C~ +70°C Installation size:φ50~60mm Installation height(suggestion):8 ~ 10 meters IP rate: IP65 Warranty : 5 years	30% when no sensor + 100% when sensor is triggered for 12 hours. all night operation.	Packing Size: #1: 1760*550*150mm #2: 400*330*230mm Net/Gross Weight:28/34KGS Packing: 1 set/2carton



Remark







- 1: Certificates:CE, ROHS CB IECCE,Saber, IP65 FCC.
- 2: Prices are based on EXW Zhuhai China.
- 3: Two years warranty for full lighting fixture
- 4: 3 ~ 7 days for samples, 15~25 days for standard orders.



Item No.	LED Power	Image	Description	Packing
AJ-A025	25W		1.Material: Aluminum Alloy 2. Solar Panel:18V 45W (Monocrystalline silicon cell) 3. LED: Bridgelux 25W 4. Battery: Lithium battery 12V 18Ah 5. Install height: 6-7M 6. Lumen: 3000LM 7. Charge time: 6 hours 8.Discharge time: ☼ Saving model: 3-5 rainy days	Product/Packing Size: 940*305*140mm/1000*390*220mm Net/Gross Weight:10.5/12KGS Packing: 1 set/carton Loading plan: 270 sets/20GP 550 sets/40'HC
AJ-A030	30W		1.Material: Aluminum Alloy 2. Solar Panel:18V 60W (Monocrystalline silicon cell) 3. LED: Bridgelux 30W 4. Battery: Lithium battery 12V 21Ah 5. Install height: 6-7M 6. Lumen: 3600LM 7. Charge time: 6 hours 8.Discharge time: *Full power:10 hours ☼ Saving model: 3-5 rainy days	Product/Packing Size: 1120*305*140mm/1180*390*220mm Net/Gross Weight:14.8/16.5KGS Packing: 1 set/carton Loading plan: 270 sets/20GP 550 sets/40'HC
AJ-A040	40W		1.Material: Aluminum Alloy 2. Solar Panel:18V 60W (Monocrystalline silicon cell) 3. LED: Bridgelux 40W 4. Battery: Lithium battery 12V 24Ah 5. Install height: 6-7M 6. Lumen: 4800LM 7. Charge time: 6 hours 8.Discharge time: ☼ Saving model: 3-5 rainy days	Product/Packing Size: 1120*305*140mm/1180*390*220mm Net/Gross Weight:14.8/16.5KGS Packing: 1 set/carton Loading plan: 270 sets/20GP 550 sets/40'HC
AJ-A050	50W		1.Material: Aluminum Alloy 2. Solar Panel:18V 80W (Monocrystalline silicon cell) 3. LED: Bridgelux 50W 4. Battery: Lithium battery 12V 36Ah 5. Install height: 8-10M 6. Lumen: 6000LM 7. Charge time: 6 hours 8.Discharge time: ☼ Saving model: 3-5 rainy days	Product/Packing Size: 1120*440*140mm/1180*530*220mm Net/Gross Weight:19/21KGS Packing: 1 set/carton Loading plan: 230 sets/20GP 470 sets/40'HC
AJ-A060	60W		1.Material: Aluminum Alloy 2. Solar Panel:18V 90W (Monocrystalline silicon cell) 3. LED: Bridgelux 60W 4. Battery: Lithium battery 12V 42Ah 5. Install height: 8-10M 6. Lumen: 7200LM 7. Charge time: 6 hours 8.Discharge time: ☼ Saving model: 3-5 rainy days	Product/Packing Size: 1120*440*140mm/1180*530*220mm Net/Gross Weight:19/21KGS Packing: 1 set/carton Loading plan: 230 sets/20GP 470 sets/40'HC
AJ-A080	80W		1.Material: Aluminum Alloy 2. Solar Panel:18V 100W (Monocrystalline silicon cell) 3. LED: Bridgelux 80W 4. Battery: Lithium battery 12V 44Ah 5. Install height: 8-10M 6. Lumen: 9600LM 7. Charge time: 6 hours 8.Discharge time: ☼ Saving model: 3-5 rainy days	Product/Packing Size: 1120*440*140mm/1180*530*220mm Net/Gross Weight:19/21KGS Packing: 1 set/carton Loading plan: 230 sets/20GP 470 sets/40'HC
AJ-A100	100W		1.Material: Aluminum Alloy 2. Solar Panel:18V 120W (Monocrystalline silicon cell) 3. LED: Bridgelux 100W 4. Battery: Lithium battery 12V 60Ah 5. Install height: 10-12M 6. Lumen: 12000LM 7. Charge time: 6 hours 8.Discharge time: ☼ Saving model: 3-5 rainy days	Product/Packing Size: 1270*540*150mm/1300*670*220mm Net/Gross Weight:29.8/30.8KGS Packing: 1 set/carton Loading plan: 130 sets/20GP 270 sets/40'HC
AJ-A120	120W		1.Material: Aluminum Alloy 2. Solar Panel:18V 130W (Monocrystalline silicon cell) 3. LED: Bridgelux 120W 4. Battery: Lithium battery 12V 66Ah 5. Install height: 10-12M 6. Lumen: 14400LM 7. Charge time: 6 hours 8.Discharge time: ☼ Saving model: 3-5 rainy days	Product/Packing Size: 1270*540*150mm/1300*670*220mm Net/Gross Weight:29.8/30.8KGS Packing: 1 set/carton Loading plan: 130 sets/20GP 270 set/40GP

Solar street light 60W with 4G/WIFI camera

Model	Picture	Function	Specification
060T-1		WIFI	<p>Solar Panel:18V/80W 820*510*25mm Li Battery:12.8V/24000MAH Brightness: full light/half light/slight light/timing Lamp beads : 3030—60pcs luminous flux: 3000LM Beam Angle:120° Lamp body:490*210*98mm Camera : 2MP, WIFI versions, 1080 pixel, 24hour working Backup : 3-4days IP:IP65; working mode :light-operated Charge time:5-6hours Discharge time:12hours at night Battery work temperature:-10°C-60°C irradiated area:40-45m² suggestion install height:4-6m</p>
060T-2		WIFI	<p>Solar Panel:18V/60W 670*510*25mm Li Battery:12.8V/18000MAH Brightness: full light/half light/slight light/timing Lamp beads : 3030—60pcs luminous flux: 2000LM Beam Angle:120° Lamp body:490*210*98mm Camera : 2MP, WIFI versions, 1080 pixel, 24hour working Backup : 3-4days IP:IP65 ;working mode :light-operated Charge time:5-6hours Discharge time:12hours at night Battery work temperature:-10°C-60°C irradiated area:30-40m² suggestion install height:4-6m</p>
060T-1B		4G	<p>Solar Panel:18V/80W 820*510*25mm Li Battery:12.8V/24000MAH Brightness: full light/half light/slight light/timing Lamp beads : 3030—60pcs luminous flux: 3000LM Beam Angle:120° Lamp body:490*210*98mm Camera : 2MP, WIFI versions, 1080 pixel, 24hour working Backup : 3-4days IP:IP65;working mode :light-operated Charge time:5-6hours Discharge time:12hours at night Battery work temperature:-10°C-60°C irradiated area:40-45m² suggestion install height:4-6m</p>

Picture	Type	Parameters					Packaging			Warranty
		Lamp	LED qty	Solar panel	Battery	Mounting height	Weight	Carton	Container	
Solar street light with Security IP camera										
	SC-NH80-S2 Wifi version	20W 3000-3500LM	60pcs	18V/80W	LiFePO4 Lithium battery 340WH/12.8V	4-6m/ \varnothing 70mm	Net Weight:21.5kg Gross Weight:23.5kg	Lamp: 725*355*280mm Panel: 834*730*62mm (29kg)	20GP:240sets 40GP:470sets	3years
	SC-NH80-S3 4G version	20W 3000-3500LM	60pcs	18V/80W	LiFePO4 Lithium battery 340WH/12.8V	4-6m/ \varnothing 70mm	Net Weight:21.5kg Gross Weight:23.5kg	Lamp: 725*355*280mm Panel: 834*730*62mm (29kg)	20GP:240sets 40GP:470sets	3years
	SC-NH100-S2 Wifi version	30W 4500-5000LM	60pcs	18V/100W	LiFePO4 Lithium battery 424WH/12.8V	6-7m/ \varnothing 70mm	Net Weight:25kg Gross Weight:27kg	Lamp: 725*355*280mm Panel: 1005*755*65mm Camera: 150*250mm (33kg)	20GP:180sets 40GP:370sets	3years
	SC-NH100-S3 4G version	30W 4500-5000LM	60pcs	18V/100W	LiFePO4 Lithium battery 424WH/12.8V	6-7m/ \varnothing 70mm	Net Weight:25kg Gross Weight:27kg	Lamp: 725*355*280mm Panel: 1005*755*65mm Camera: 150*250mm (33kg)	20GP:180sets 40GP:370sets	3years
	SC-NH150-S2 Wifi version	40W 6000-6500LM	60pcs	18V/120W	LiFePO4 Lithium battery 505WH/12.8V	10-12m/ \varnothing 70mm	Net Weight:25kg Gross Weight:27kg	Lamp: 745*370*390mm Panel: 1135*765*70mm (33kg)	20GP:140sets 40GP:290sets	3years
	SC-NH150-S3 4G version	40W 6000-6500LM	60pcs	18V/120W	LiFePO4 Lithium battery 505WH/12.8V	10-12m/ \varnothing 70mm	Net Weight:25kg Gross Weight:27kg	Lamp: 745*370*390mm Panel: 1135*765*70mm (33kg)	20GP:140sets 40GP:290sets	3years







Mini Order: Formal order 100sets after sample testing. Lead time will be 1-2weeks after receipt of deposit.

Order less than \$5000, above price is EXW.

Payment term: T/T(30% in advance, balance before shipment),Western Union,MoneyGram,Paypal,L/C.

Package: Standard carton box packing.

All in two solar power street lamps

Model	Power	PICTURE	DESCRIPTION	PACKING DETAILS
EA-N20W	20W		<ol style="list-style-type: none"> 1. Material: Die-cast aluminum 2. Light source: Philips SMD3030 3. LED Qty: 60pcs 4. Battery: Lithium-iron 12V 20AH 5. Solar Panel: Monocrystalline 18V50W 6. Suggest installation height: 5m 7. Lighting time: 12 hours 8. Lumens: 2800LM 9. Charging time: 6 hours 10. Autonomy days: 3-5 Raining days 11. Warranty: 3 years 12. Intelligent Solar Power Controller 	Product Size: 500*200*78MM Package dimensions: 520*220*120MM G.W:5KG
EA-N40W	40W		<ol style="list-style-type: none"> 1. Material: Die-cast aluminum 2. Light source: Philips SMD3030 3. LED Qty: 60pcs 4. Battery: Lithium-iron 12V 30AH 5. Solar Panel: Monocrystalline 18V70W 6. Suggest installation height: 6m 7. Lighting time: 12 hours 8. Lumens: 5600LM 9. Charging time: 6 hours 10. Autonomy days: 3-5 Raining days 11. Warranty: 3 years 12. Intelligent Solar Power Controller 	Product Size: 500*200*78MM Package dimensions: 520*220*120MM G.W:5.5KG
EA-N60W	60W		<ol style="list-style-type: none"> 1. Material: Die-cast aluminum 2. Light source: Philips SMD3030 3. LED Qty: 60pcs 4. Battery: Lithium-iron 12V 40AH 5. Solar Panel: Monocrystalline 18V80W 6. Suggest installation height: 8m 7. Lighting time: 12 hours 8. Lumens: 8400LM 9. Charging time: 6 hours 10. Autonomy days: 3-5 Raining days 11. Warranty: 3 years 12. Intelligent Solar Power Controller 	Product Size: 500*200*78MM Package dimensions: 520*220*120MM G.W:5.8KG
EA-N80W	80W		<ol style="list-style-type: none"> 1. Material: Die-cast aluminum 2. Light source: Philips SMD3030 3. LED Qty: 120pcs 4. Battery: Lithium-iron 12V 50AH 5. Solar Panel: Monocrystalline 18V120W 6. Suggest installation height: 10m 7. Lighting time: 12 hours 8. Lumens: 11200LM 9. Charging time: 6 hours 10. Autonomy days: 3-5 Raining days 11. Warranty: 3 years 12. Intelligent Solar Power Controller 	Product Size: 600*253*100MM Package dimensions: 650*280*150MM N.W/G.W:7.5KG
EA-N40W-A	40W with 4G camera		<ol style="list-style-type: none"> 1. Material: Die-cast aluminum 2. Light source: Philips SMD3030 3. LED Qty: 120pcs 4. Battery: Lithium-iron 12V 60AH 5. Solar Panel: Monocrystalline 18V120W 6. Suggest installation height: 6-8m 7. Lighting time: 12 hours 8. Lumens: 6000LM 9. Charging time: 6 hours 10. Autonomy days: 3-5 Raining days 11. Warranty: 3 years 12. Intelligent Solar Power Controller 13. With CCTV 4G 	Product Size: 500*200*78MM Package dimensions: 520*220*120MM G.W:5KG
EA-N70W-A	70W with 4G camera		<ol style="list-style-type: none"> 1. Material: Die-cast aluminum 2. Light source: Philips SMD3030 3. LED Qty: 120pcs 4. Battery: Lithium-iron 12V 90AH 5. Solar Panel: Monocrystalline 18V200W 6. Suggest installation height: 7-9m 7. Lighting time: 12 hours 8. Lumens: 10,500LM 9. Charging time: 6 hours 10. Autonomy days: 3-5 Raining days 11. Warranty: 3 years 12. Intelligent Solar Power Controller 13. With CCTV 4G (360-degree rotatable) 	Product Size: 600*253*100MM Package dimensions: 650*280*150MM N.W/G.W:7.5KG

All in two solar street light 30W-80W, 12hours at night , backup 3 rainy days

Item No.	Photo		Features & Specifications		Packaging Details & Product Material
AL-HY30W			Solar Panel	18V/70W/mono	Packing Details: 1. Solar Panel Size : 610x670x45mm 2. Product Size : 650x220x200mm 3.N.W/G.W:13kg/*15kg 4. Carton size : 690*260*220mm(lamp); 630*690*60mm(solar panel) 1. Material: Aluminum + Steel glass 2. LED: > 160lm/ W (Bridgelux 45ML) 3. Mounting Height:6m 4. Discharge Time: > 12 Hours 5. Charge Time:6 Hours Strong Sunenergy 6. Certificates:CE RoHS,IP65,ISO 7. Function: Photo cell Switch + Timer control + Motion Sensor.
			Lithium Battery	12V/216WH	
			Light Efficiency	140LM/W	
			Lumens	4200LM	
			CRI	RA > 70	
			Color Temperature	3000K-6500K	
			IP Rate	IP65	
			Light Source	Bridgelux LED/40 pieces	
			LED Lifespan	50000H	
			Conversion Efficiency	≥0.95	
Working Temperature	-30°C~+60°C				
AL-HY40W			Solar Panel	18V/70W/mono	Packing Details: 1. Solar Panel Size : 610x670x45mm 2. Product Size : 650x220x200mm 3.N.W/G.W:14kg/*16kg 4. Carton size : 690*260*220mm(lamp); 630*690*60mm(solar panel) 1. Material: Aluminum + Steel glass 2. LED: > 160lm/ W (Bridgelux 45ML) 3. Mounting Height: 6 ~7m 4. Discharge Time: > 12 Hours 5. Charge Time:6 Hours Strong Sunenergy 6. Certificates:CE RoHS,IP65,ISO 7. Function: Photo cell Switch + Timer control + Motion Sensor.
			Lithium Battery	12V/240WH	
			Light Efficiency	140LM/W	
			Lumens	5600LM	
			CRI	RA > 70	
			Color Temperature	3000K-6500K	
			IP Rate	IP65	
			Light Source	Bridgelux LED/40 pieces	
			LED Lifespan	50000H	
			Conversion Efficiency	≥0.95	
Working Temperature	-30°C~+60°C				
AL-HY60W			Solar Panel	18V/80W/mono	Packing Details: 1. Solar Panel Size : 670x676x45mm 2. Product Size : 650x220x200mm 3.N.W/G.W:16kg/18kg 4. Carton size : 690*260*220mm(lamp); 690*696*60mm(solar panel) 1. Material: Aluminum + Steel glass 2. LED: > 160lm/ W (Bridgelux 45ML) 3. Mounting Height: 7 ~8m 4. Discharge Time: > 12 Hours 5. Charge Time:6 Hours Strong Sunenergy 6. Certificates:CE RoHS,IP65,ISO 7. Function: Photo cell Switch + Timer control + Motion Sensor.
			Lithium Battery	12V/470WH	
			Light Efficiency	160LM/W	
			Lumens	9600LM	
			CRI	RA > 70	
			Color Temperature	3000K-6500K	
			IP Rate	IP65	
			Light Source	CREE LED/40pieces	
			LED Lifespan	50000H	
			Conversion Efficiency	≥0.95	
Working Temperature	-30°C~+60°C				
AL-HY80W			Solar Panel	18V/100W/mono	Packing Details: 1. Solar Panel Size : 870x670x45mm 2. Product Size : 850x220x200mm 3.N.W/G.W:20kg/22kg 4. Carton size : 870*260*220mm(lamp); 890*690*60mm(solar panel) 1. Material: Aluminum + Steel glass 2. LED: > 160lm/ W (Bridgelux 45ML) 3. Mounting Height: 7 ~8m 4. Discharge Time: > 12 Hours 5. Charge Time:6 Hours Strong Sunenergy 6. Certificates:CE RoHS,IP65,ISO 7. Function: Photo cell Switch + Timer control + Motion Sensor.
			Lithium Battery	12V/666WH	
			Light Efficiency	160LM/W	
			Lumens	12800LM	
			CRI	RA > 70	
			Color Temperature	3000K-6500K	
			IP Rate	IP65	
			Light Source	CREE LED/80pieces	
			LED Lifespan	50000H	
			Conversion Efficiency	≥0.95	
Working Temperature	-30°C~+60°C				
	Type	Height	Top diameter	Bottom diameter	Thickness
	Hot dip galvanized steel pipe White body	5m	70mm	130mm	3mm
		6m	70mm	142mm	3mm

	7m	70mm	154mm	3mm
	8m	70mm	166mm	3mm







Remarks:

1. Body material:aluminium alloy.
2. Solar panel with high efficiency monocrystalline silicon.
3. Lighting time is about 3 days. Solar battery charging.
4. Sample Policy: Sample should be paid, delivery time within 3 workdays.
5. Mini Order: 10sets. LSCd time will be 5 workdays after receipt of deposit.
6. Payment term: T/T(30% in advance, balance before shipment),Western Union,Paypal,L/C.
7. Package: Neutral packing. Three ySCrs warranty.
- 8.Three ySCrs warranty, if 5 ySCrs warranty, need 5% extra charge.



2/3/4MP Solar 4G/WIFI camera (low power 4G ball machine)

Model	Picture	4G/WIFI versions	parameter	Packing
3MUB	<p>APP:Smain</p> 	4G/WIFI versions	<ol style="list-style-type: none"> 1. 3MP ultra clear picture, clear and delicate image. 2. Rapid start in 300 milliseconds. 3. High efficiency solar charging technology, low light can also be charged to ensure that the equipment will never be powered off. 4. Supports cloud storage and TF card recording storage, and supports a maximum capacity of 256g TF card. 5. Built in high sensitivity mic and speaker, supporting two-way voice intercom. 6. The infrared white light dual light design supports three adjustable night vision modes to realize full-color at night. 7. Support mobile phone remote monitoring and view the live scene anytime, anywhere. 	Ctns : 4sets/ctns G.W: 14.5kg Outside of ctns: 495*358*402mm
UB01	 	WIFI	Camera lens: 3.6mm Lighting: infrared + white light 30M Detection mode: PIR human body sensing +AI humanoid detection Detection range: 0~ 12 meters Storage: Cloud storage +TF card (maximum 128GB) Head: horizontal 355 ° vertical 100°	Ctns : 4sets/ctns G.W: 14.5kg Outside of ctns: 495*358*402mm
		Asian	Mono Solar panel: 20W Battery : built-in 8pcs18650(3000MAH*8=24000MAH) Voice: Two-way voice intercom	
		European	Max working power:4W Standby power 0.003W	
UB02	 	WIFI	Camera lens: 3.6mm Lighting: infrared + white light 30M Detection mode: PIR human body sensing +AI humanoid detection Detection range: 0~ 12 meters Storage: Cloud storage +TF card (maximum 128GB) Head: horizontal 355 ° vertical 100	Ctn: 6set/ctns G.W: 14.95kg Ctn size: 615*300*360mm
		Asian	Mono solar panel: 8W Battery : built-in 6 pcs18650(2600MAH*6=15600MAH) Voice: Two-way voice intercom	
		European	Max working power:4W Standby power 0.003W	
UB03	 	WIFI	Camera lens: 3.6mm Lighting: infrared + white light 30M Detection mode: PIR human body sensing +AI humanoid detection Detection range: 0~ 12 meters Storage: Cloud storage +TF card (maximum 128GB) Head: horizontal 355 ° vertical 100°	ctn:6set/ctn G.W: 14.95kg Carton size:615*300*360 mm
		Asian	Mono solar panel:8W Battery:Built-in 6pcs18650(2600MAH*6=15600MAH) Voice: Two-way voice intercom	
		European	Max working power:4W Standby power 0.003W	
UB04		WIFI	Camera lens: 3.6mm Lighting: infrared + white light 30M Detection mode: PIR human body sensing +AI humanoid detection Detection range: 0~ 12 meters Storage: Cloud storage +TF card (maximum 128GB) Head: horizontal 355 ° vertical 100°	CTN : 9set/ctn G.W : 16kg CTN size : 570*258*472mm
		Asian	Mono Solar panel:6W Battery : 4pcs18650(3000MAH*4=12000MAH) Voice: Two-way voice intercom	
		European	Max working power:4W Standby power 0.003W	
UB05	 	WIFI	Camera lens: 3.6mm Lighting: infrared + white light 30M Detection mode: PIR human body sensing +AI humanoid detection Detection range: 0~ 12 meters Storage: Cloud storage +TF card (maximum 128GB) Head: horizontal 355 ° vertical 100°	CTN : 12set/ctn G.W : 12.5kg CNT size : 485*221*493mm
		Asian	Mono solar panel: 3.5W Battery : 3pcs18650(3000MAH*3=9000MAH) Voice: Two-way voice intercom	
		European	Max working power:2.5W Standby power 0.003W	

Solar ceiling light (Hotsky)

Item No.	LED Power	Image	Description
XD-30W	30W		Solar panel size: 3W Battery type: LiFePO4 32650 Battery capacity: 5000mAh Number of lamp beads: 54 Lamp bead model: 5730 Lamp body diameter: 20cm Lamp body material: ABS+ PC Charging time: 5-6 hours Lighting time: 12 hours Working mode: remote control + light control
XD-50W	50w		Solar panel size: 8W 350*235 mm Battery type: LiFePO4 32650 Battery capacity: 6000mAh Number of lamp beads: 76 three-color dimming Lamp bead model: 5730 Lamp body diameter: 24 cm Lamp body material: ABS+ PC Charging time: 5-6 hours Lighting time: 12 hours Working mode: remote control + light control
XD-100W	100W		Solar panel size: 15W 350*350 mm Battery type: LiFePO4 32650 Battery capacity: 12000 mAh Number of lamp beads: 110 three-color dimming Lamp bead model: 5730 Lamp body diameter: 28 cm Lamp body material: ABS+ PC Charging time: 5-6 hours Lighting time: 12 hours Working mode: remote control + light control
XD-150W	150w		Solar panel size: 20W 450*350 mm Battery type: LiFePO4 32650 Battery capacity: 18000 mAh Number of lamp beads: 170 three-color dimming Lamp bead model: 5730 Lamp body diameter: 32 cm Lamp body material: ABS+ PC Charging time: 5-6 hours Lighting time: 12 hours Working mode: remote control + light control
XD-200W	200w		Solar panel size: 25W 530*350 mm Battery type: LiFePO4 32650 Battery capacity: 24000mAh Number of lamp beads: 190 three-color dimming Lamp bead model: 5730 Lamp body diameter: 36 cm Lamp body material: ABS+ PC Charging time: 5-6 hours Lighting time: 12 hours Working mode: remote control + light control
EC-GK-50W	50w		Solar panel size: 15W 350*350mm Battery type: LiFePO4 32650 Battery capacity: 12000mAh Number of lamp beads: 54 Lamp Bead Model: 2835 Lamp Body Diameter: 35 cm Lamp body material: ABS+ aluminum Charging time: 5-6 hours Lighting time: 12 hours Working mode: remote control + light control
EC-GK-100W	100w		Solar panel size: 18W 400*350mm Battery type: LiFePO4 32650 Battery capacity: 18000mAh Number of lamp beads: 120 Lamp bead model: 5730 Lamp body diameter: 40 cm Lamp body material: ABS+ aluminum Charging time: 5-6 hours Lighting time: 12 hours Working mode: remote control + light control

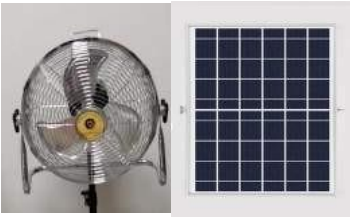
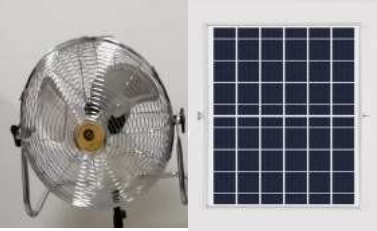

Hybrid Solar Power Fan (DC/AC)

Picture	Model	Description
	A15-01	<p>12 Inch Solar Fan Solar Panel: 15V 24W, Polycrystalline Battery Type: Lithium-Ion 11.1V 5AH Charging Time: 3-5 Hours Discharging Time: 6-8 Hours 1xUSB Output: 5V 1A Material: ABS+Iron Lamp Size: 420*200*400mm Warranty: 3 Years</p>
	ZH-310	<p>10inch Hybrid Solar Fan 1xBluetooth audio Solar panel: 18W polysilicon a panel 18V Battery capacity: 18650 5AH 11.1V Charger: 2A adapter charger Gear: 5th gear , blade material : stainless steel materials Charging time: 3-5h Service time: 7 hours for 5th gear, 10-11 hours for 1st gear. Function mode: USB charging interface Fan size: 10 inches Solar panel size: 350 * 290mm 2XUSB port 2A 1A Bluetooth audio Packing quantity: 6 sets / box Box size: Full container weight: Product color: silver</p>
	ZH-312	<p>12inch Hybrid Solar Fan 1xBluetooth audio Solar panel: 18W polysilicon a panel 18V Battery capacity: 18650 5AH 11.1V Charger: 2A adapter charger Gear: 5th gear , blade material : stainless steel materials Charging time: 3-5h Service time: 7 hours for 5th gear, 10-11 hours for 1st gear. Function mode: USB charging interface Fan size: 12 inches Solar panel size: 350 * 290mm 2XUSB port 2A 1A Bluetooth audio Packing quantity: 6 sets / box Box size: Full container weight:</p>
	HXT-314	<p>14inch Hybrid Solar Fan 1xBluetooth audio Solar panel: 18W polysilicon a panel 18V Battery capacity: 18650 5AH 11.1V Charger: 2A adapter charger Gear: 5th gear , blade material : stainless steel materials Charging time: 3-5h Service time: 7 hours for 5th gear, 10-11 hours for 1st gear. Function mode: USB charging interface Fan size: 14 inches Solar panel size: 350 * 290mm 2XUSB port 2A 1A Bluetooth audio Packing quantity: 6 sets / box Box size: Full container weight: Product color: silver</p>

Price List of **ECONOMY** Solar Tube Batten Light Kit 12W-80W

Solar Light Fixture	Model NO.	Power	Specification	Funcntions	Package
	DG10W	10W	Solar lamp parameters: Solar panel: 6V6w Board size: 270X180mm Lamp size: 270*27*27 mm Battery capacity: 2200mAh Lamp beads: 18650 high-brightness lamp beads, 28 pieces, plus 18 strobe light beads Tube material: plastic PPC Packing quantity: 20pcs Irradiation area: 60 square meters	* 100% Full Power * +20% - 20% * 0% + 100% sensor * 30% + 100% sensor * USB 5V to charge mobile * Connect to external wall switch.	Unit Box : 37.5X 31X46cm Qty/Carton : 20 Sets N.W: 19.50Kg G.W: 22.30Kg
	E360	12W	Light fixture size : 60*85*360mm LED Peak Power: 12W±0.5W Lumen Flux :> 1200lm LED Quantity : SMD2835 60pcs Battery Capacity : 3.7V 12.2AH Solar Panel: 6V 10W Cable Length : 5M IP rate: IP65 With Remote Control With mounting brackets	* 100% Full Power * +20% - 20% * 0% + 100% sensor * 30% + 100% sensor * USB 5V to charge mobile * Connect to external wall switch.	Unit Box : 41*20*11cm Qty/Carton : 10 Sets Carton Size : 56*42*40cm N.W: 19.50Kg G.W: 22.30Kg
	E600	24W	Light fixture size : 60*85*600mm LED Peak Power: 24W±0.5W Lumen Flux :> 2500lm LED Quantity : SMD2835 120pcs Battery Capacity : 3.7V 24.4AH Solar Panel: 6V 18W Cable Length : 5M IP rate: IP65 With Remote Control With mounting brackets	* 100% Full Power * +20% - 20% * 0% + 100% sensor * 30% + 100% sensor * USB 5V to charge mobile * Connect to external wall switch.	Unit Box : 63*20*11cm Qty/Carton : 6 Sets Carton Size : 65*42*35cm N.W: 17.60Kg G.W: 18.50Kg
	EC20-01	20W	20W Solar LED Tri Proof Light LED Lamp: 2835 LED 120PCS 6000K Solar Panel: 9V 15W, Mono-Crystalline Battery Type: LiFePO4 6.4V 12AH Charging Time: 6-8 hours Discharging Time: 20-24 hours Led: 160 lm/w Material: Aluminum+PC Product Size: 445*120*120mm Warranty: 3 years	* 100% Full Power * +20% - 20% * 0% + 100% sensor * 30% + 100% sensor * USB 5V to charge mobile"	Unit solar panel Box : 43*35.5*21.5cm 15.5KG Unit solar panel Box : 52*47*27.5 17.1KG Qty/Carton : 8 Sets N.W: 31.50Kg G.W: 32.6Kg
	EC40-01	40W	40W Solar LED Tri Proof Light LED Lamp: 2835 LED 180PCS 6000K Solar Panel: 9V 20W, Mono-Crystalline Battery Type: LiFePO4 6.4V 18AH Charging Time: 6-8 hours Discharging Time: 20-24 hours Led: 160 lm/w Material: Aluminum+PC Product Size: 625*120*120 mm Warranty: 3 years	* 100% Full Power * +20% - 20% * 0% + 100% sensor * 30% + 100% sensor * USB 5V to charge mobile"	Unit solar panel Box : 61.*35.5*21.5cm 20.5KG Unit solar panel Box : 65*52.5*27.5cm 21.6KG Qty/Carton : 8 Sets N.W: 41.10Kg G.W: 42.5Kg
	EC60-01	60W	60W Solar LED Tri Proof Light LED Lamp: 2835 LED 240PCS 6000K Solar Panel: 9V 28W, Mono-Crystalline Battery Type: LiFePO4 6.4V 24AH Charging Time: 6-8 hours Discharging Time: 20-24 hours Led: 160 lm/w Material: Aluminum+PC Product Size: 805*120*120 mm Warranty: 3 years	* 100% Full Power * +20% - 20% * 0% + 100% sensor * 30% + 100% sensor * USB 5V to charge mobile"	Unit solar panel Box : 79.5*27*21.5cm 24.3KG Unit solar panel Box : 83*39.5*27.5cm 23.5KG Qty/Carton : 6 Sets N.W: 46.50Kg G.W: 47.8Kg
	EC80-01	80W	80W Solar LED Tri Proof Light LED Lamp: 2835 LED 300PCS 6000K Solar Panel: 9V 38W, Mono-Crystalline Battery Type: LiFePO4 6.4V 30AH Charging Time: 6-8 hours Discharging Time: 20-24 hours Led: 160 lm/w Material: Aluminum+PC Product Size: 1035*120*120 mm Warranty: 3 years	* 100% Full Power * +20% - 20% * 0% + 100% sensor * 30% + 100% sensor * USB 5V to charge mobile"	Unit solar panel Box : 104*18.5*20.5cm 17.3KG Unit solar panel Box : 108.5*20.5*25cm 18.5KG Qty/Carton : 4 Sets N.W: 34.50Kg G.W: 35.8Kg

For Project



	AI-X2200 (600mm)	18W	Light Size : 92*84*600mm * LED Power: 18W±0.5W * Lumen Flux :> 2,200lm * LED : SMD2835 192pcs * Battery : 216VWH 12V * CCT : 3000K/4000K/6000K * Cable Length : 5M * Programmable by remote * IP67 IK10 * Default Setting : 50% + 100% * Charge Time : 4 Hours * Warranty : 2 years	Solar panel Peak Power: 60W (Foldable) * Rated Vol : 18V * Peak current : 3.3A * Mono cell made in Taiwan * Waterproof Cable: 0.7M * Warranty : 5 years	
	AI-X4800 (900mm)	36W	* Light Size : 92*84*900mm * LED Power: 36W±4.0W * Lumen Flux :> 4,800lm 6000K * LifePO4 Battery : 12.8V 24AH * Motion sensor : Microwave * Cable Length : 5M * Programmable by remote * Aluminium alloy * Adjustable : Yes	* Peak Power: 80W * Rated Vol : 18V * Peak current : 4.45A * Monocrystalline * Cable with MC4: 0.7M * Warranty : 3 years	
	Solar Panel Bracket				

MOQ: ONE CARTON/MODEL



UFO solar garden lamp with App

Model	Picture	Product Description
HLN-500W	 <p>The image shows the HLN-500W UFO solar garden lamp. It features a circular top with a solar panel and a central light fixture. Two callouts point to the solar panel and the light fixture. Below the main image are three smaller images showing the lamp from different angles.</p>	<p>Solar UFO garden lamp 500W Solar panel: polycrystalline 6V15w Lamp size: 42*42cm Battery: Lithium iron phosphate battery 3.2V 18000mah SMD lamp beads:750 lamp beads of the Changfang brand 2835 model, color temperature 6500k Material: Die-cast aluminum Waterproof rating: IP67 Charging time: 4-6H Lighting time: 12-15 hours of sustainable lighting Irradiation area: about 100 square meters Control mode: remote control, light control Packing number: 5 set/carton</p>
HLN-1000W	 <p>The image shows the HLN-1000W UFO solar garden lamp. It features a circular top with a solar panel and a central light fixture. A red banner at the top of the image reads 'LED Solar Light'. Below the main image are three smaller images showing the lamp from different angles.</p>	<p>Solar UFO garden lamp 1000W Solar panel: polycrystalline 6V20w Lamp size: 55*55 cm Battery: Lithium iron phosphate battery 3.2V 24000mah SMD lamp beads:720 lamp beads of the Changfang brand 2835 model, color temperature 6500k Material: Die-cast aluminum Waterproof rating: IP67 Charging time: 4-6H Lighting time: 12-15 hours of sustainable lighting Irradiation area: about 200 square meters Control mode: remote control, light control Packing number: 5 set/carton</p>
UFO-500W	 <p>The image shows the UFO-500W UFO solar garden lamp. It features a circular top with a solar panel and a central light fixture. Below the main image are two smaller images showing the lamp from different angles.</p>	<p>Solar UFO garden lamp 500W Solar panel: polycrystalline 6V27w Lamp size: 61*61 cm Battery: Lithium iron phosphate battery 3.2V 24000mah SMD lamp beads:450 lamp beads of the Changfang brand 2835 model, color temperature 6500k Material: Die-cast aluminum Waterproof rating: IP67 Charging time: 4-6H Lighting time: 12-15 hours of sustainable lighting Irradiation area: about 200 square meters Control mode: remote control, light control Packing number: 5 set/carton</p>
A20-01	 <p>The image shows the A20-01 20W Solar LED Garden Light. It features a square top with a solar panel and a central light fixture. Below the main image are two smaller images showing the lamp from different angles.</p>	<p>20W Solar LED Garden Light LED Lamp: 2835 LED 84PCS 6000K Solar Panel: 6V 18W, Polycrystalline Battery Type: LiFePO4 3.2V 36AH Charging time: 6-8 hours Discharging time: 20-24 hours LED: 160 lm/w Material: Die-casting aluminum+PC Product Size: 400*400*405mm Warranty: 3 years</p>
A20-03	 <p>The image shows the A20-03 20W Solar LED Garden Light. It features a square top with a solar panel and a central light fixture. Below the main image are two smaller images showing the lamp from different angles.</p>	<p>20W Solar LED Garden Light LED Lamp: 2835 LED 84PCS 6000K Solar Panel: 6V 18W, Polycrystalline Battery Type: LiFePO4 3.2V 36AH Charging Time: 6-8 Hours Discharging Time: 20-24 Hours LED: 160 lm/w Material: Die-casting Aluminum+PC Product Size: 400*400*405mm Warranty: 3 Years</p>

<p>MJ-EW800 With App</p>		<p>Battery:LiFePO4 32Ah Solar panel : Poly 4V/30W LED chips qty: 186 pcs SMD5730 (white),186 pcs SMD5730 (warm white), 36 pcs SMD5054(RGB) Shell Material:Die-casting Aluminium+PC(Anti-UV material) Light Size:diameter 580MM,Height 248MM,Inner diameter of the sleeve is 78MM Discharge time:2-3 rainy days Luminous Flux:2029lm irradiated area:200㎡ Lighting Model:White & Warm white switchRGB 16million colors selectable Features:Intelligent light control+ Remote control +APP Bluetooth Music Rhythm Installation pole height:3-5m Accessories:Remotecontrol/screws</p>
<p>MJ-EW1200 With App</p>		<p>Battery:LiFePO4 48Ah Solar panel:Mono 4V/40W LED chips qty: 186 pcs SMD5730 (white),186 pcs SMD5730 (warm white), 36 pcs SMD5054(RGB); Shell Material:Die-casting Aluminium+PC(Anti-UV material) Light Size:diameter 580MM,Height 248MM,Inner diameter of the sleeve is 78MM. Discharge time:4-6 rainy days. Luminous Flux:2679lm. irradiated area:350㎡ CCT:3500-4000K & 6500-7000KRGB 16million colors selectable. Lighting Model:White & Warm white switch RGB 16 million colors selectable. Features:Intelligent light control+ Remote control +APP Bluetooth Music Rhythm. Installation pole height:4-6m.</p>
<p>AI-GL600R</p>		<p>Battery:LiFePO4 12.8V 154WH (12.8V12Ah) Solar panel:Mono 18V/42W Rated Power: 18W 12V 128pcs SMD2835 Max Load:30W/12v Shell Material:Die-casting Aluminium+PC(Anti-UV material) Light Size:diameter 580MM,Height 435MM,Inner diameter of the sleeve is 76MM. Discharge time:3-4 rainy days. Luminous Flux: >2800lm. irradiated area:200㎡ CCT:3500-4000K & 6500-7000K Lighting Model:Constant lighting with fixed power or 30% + 100% motion detection mode Features:Intelligent light control+ Remote control Installation pole height:3-5m. Accessories:Remotecontrol/screws.</p>
<p>AI-GL570R</p>		<p>Model NO.:AI-GL570R Fixture material:Alu die casting+polycarbonate Fixture color:Slivery / Black / Customized color Lamp size:φ570*H550mm LED source:128pcs smd3030 LED power:18W max Liminous flux:>2,800lm CCT:3000K+4000Kor 3000K+6000K CRI:>83 Default light program:4H 100%+4H 50%+5H 30% Motion sensor mode:30%+100% triggered sensor Sensor type: Microwave sensor LifePO4 battery:12.8V 154WH Battery lifetime:>3000 cycles D.O.D : 70% Charge controller:MPPT 97% Solar Panel:38W 18V monocrystalline Brightness level:20-40-60-80-100% Working time options:4Hours/ 6Hours/ 12Hours Working Temp:-20°C-70°C Remote control:PIR IP Rate:IP65 Pole diameter to install:76mm Net weight:11.5Kg Gross weight:12.80Kg Qty/carton:1 Unit Light carton size:63*63*28CM Warranty:3 Years</p>

Split type 3 m light pole		Material:Galvanizedstreet pole Pole height:3m Light pole diameter:the upper diameter 114 mm;the lower diameter of 76mm Light pole flange:220*220*8MM Light pole wall thickness:1.5mm Splice pole: 3pcs,per 1m Accessories:Splicingscrew
Split type 5m light pole		Material:Galvanizedsteel pole Pole height:5m Light pole diameter:the upper diameter 114 mm;the lower diameter of 76mm Light pole flange:220*220*8MM Light pole wall thickness:1.5mm Splice pole: 4pcs,per 1m Accessories:Splicingscrew



Solar Power Moonlight





No.	Picture	Specification		Packing				
		Model Number		Length	Width	Hight		
1		Model Number	EA-MJ-10W	Carton Size:	49	45	34	Light Control
		Product Name:	6W Moonlight					
		Solar Panle:	Poly 10W					
		Battery:	3.2V/10Ah Lifepo4 Battery	Carton Volume/CBM	0.07			Remote Control
		JED Brand:	Samsung					
		Working Temperature:	-20°C-60°C					
		CCT:	6000-6500K	Qty /Carton	2			Microwave
		Working Hours:	8-12h	20' GP	694			
		Charging Hours:	6-8h	40'GP	1494			
		Function:	Light control, daytime solar panels on the battery charge, automatic light at	40'HQ	2294			
		Protection:	IP55	Netweight				
		Material:	Aluminum alloy+PC	Gross weight :	7.2KG			
		Color	Silver	Netweight(1CTN):				
Size:		Gross weight (1CTN):				Remark		
Others:	ON/OFF Switch							
2		Model Number	EA-MJ-25W	Carton Size:	55	51	41	Light Control
		Product Name:	9W Moonlight Wall Light					
		Solar Panle:	Poly 25W					
		Battery:	3.2V/15Ah Lifepo4 Battery	Carton Volume/CBM	0.12			Remote Control
		JED Brand:	Samsung					
		Working Temperature:	-20°C-60°C					
		CCT:	6000-6500K	Qty /Carton	2			Microwave
		Working Hours:	8-12h	20' GP	452			
		Charging Hours:	6-8h	40'GP	974			
		Function:	Light control, daytime solar panels on the battery charge, automatic light at	40'HQ	1496			
		Protection:	IP55	Netweight				
		Material:	Aluminum alloy+PC	Gross weight :	12KG			
		Color	Silver	Netweight(1CTN):				
Size:		Gross weight (1CTN):				Remark		
Others:								





3		Model Number	EA-MJ-35W		Length	Width	Hight	Microwave
		Product Name:	12W Moonlight (big)	Carton Size:	55	51	41	
		Solar Panle:	Poly 35W					
		Battery:	3.2V/30Ah Lifepo4 Battery	CartonVolume/CBM	0.12			
		LED Brand:	Saide	CartonVolume/CUFT	4.06			
		Working Temperature:	-20°C-60°C	Qty/Colorbox	0			
		CCT:	6000-6500K	Qty /Carton	2			
		Working Hours:	8-12h	20' GP	452			
		Charging Hours:	6-8h	40'GP	974			
		Function:	Light control, daytime solar panels on the battery charge, automatic light at	40'HQ	1496			
		Protection:	IP55	Netweight				
		Material:	Aluminum alloy+PC	Gross weight :	12KG			
		Color	Silver	Netweight(1CTN):				
		Size:		Gross weight (1CTN):				
		Others:		Remark				



Solar flood lamp





Model	Picture	Function	Specification
V2-PRO	 <p>\$Zero Utility Cost designed for premium</p>	White verision/RGBCW verision	<p>Model NO.V2-PRO Lamp size:240*168*52mm LED power : 4.8±0.5 Watts Luminous flux:880lm Solar panel:10V 12W LifePO4 battery:6.4V 38.4WH Carton & qty:54*32*38cm / 6pcs N.W/ G.W:18.7kg / 20.8kg Common specification *Material : aluminium die casting CCT : 3000K-6000K /RGBCW Battery lifetime : > 2000 cycles Cable length : 5 meters Remote control : 360° 2.4G " *Motion sensor : microwave (up to 15m) Brightness & time adjustable : Yes Body color : black / customzied Warranty : 2 years Certificates: CE, ROHS"</p>
V4-PRO	 <p>\$Zero Utility Cost designed for premium</p>	White verision/RGBCW verision	<p>Model NO.:V4-PRO Lamp size:305*235*52mm LED power:9.0±0.5 Watts Luminous flux:1,680lm Solar panel:10V 25W LifePO4 battery:6.4V 76.8WH Carton & qty:56*29*38cm / 4pcs N.W/ G.W:17.8kg / 19.5kg Common specification *Material : aluminium die casting CCT : 3000K-6000K /RGBCW Battery lifetime : > 2000 cycles Cable length : 5 meters Remote control : 360° 2.4G " *Motion sensor : microwave (up to 15m) Brightness & time adjustable : Yes Body color : black / customzied Warranty : 2 years Certificates: CE, ROHS"</p>
V6-PRO	 <p>\$Zero Utility Cost designed for premium</p>	White verision/RGBCW verision	<p>Model NO.:V6-PRO Lamp size:375*275*52mm LED power:13.5±0.5 Watts Luminous flux:2,480lm Solar panel:10V 35W LifePO4 battery:6.4V 115WH Carton & qty:74*28*44cm / 4pcs N.W/ G.W:22.6kg / 24.7kg Common specification *Material : aluminium die casting CCT : 3000K-6000K /RGBCW Battery lifetime : > 2000 cycles Cable length : 5 meters Remote control : 360° 2.4G " *Motion sensor : microwave (up to 15m) Brightness & time adjustable : Yes Body color : black / customzied Warranty : 2 years Certificates: CE, ROHS"</p>
V8-PRO	 <p>\$Zero Utility Cost designed for premium</p>	White verision/RGBCW verision	<p>Model NO.:V8-PRO Lamp size:375*275*52mm Luminous flux:18.5±0.5 Watts Solar panel:3,280lm LifePO4 battery:10V 50W Carton size:6.4V 154WH Qty/carton:74*15*44cm / 2pcs N.W/ G.W:13.4kg / 15.2kg Common specification *Material : aluminium die casting CCT : 3000K-6000K /RGBCW Battery lifetime : > 2000 cycles Cable length : 5 meters Remote control : 360° 2.4G " *Motion sensor : microwave (up to 15m) Brightness & time adjustable : Yes Body color : black / customzied Warranty : 2 years Certificates: CE, ROHS"</p>





<p>EC-332C</p>		<p>Light control, time control, remote control (can be customized with radar)</p>	<p>Product name:Solar Flood light 300W Model NO.:EC-332C Power:300W Working model:Light control, time control, remote control (can be customized with radar) LifePO4 battery:3.2V 18000mAh Solar Panel:6v25W 450*350*18MM LED size:260*330*80mm light source:Epistar Chip 332pcs 5730 beads IP:IP67 Charge time:5-6hours Discharge time:12-16hours Battery Working Temperature: (-10°C) -60°C Liminous flux:10000lm Beam Angle:120° install height:4-6m irradiated area:120-150㎡ Lamp holder carton:53*41.5*37.5CM,20KG (10pcs/ctn) Solar Panel packing:48.5*29.5*38.5CM 23KG (10pcs/ctn)</p>
<p>EC-416C</p>		<p>Light control, time control, remote control (can be customized with radar)</p>	<p>Product name:Solar Flood light 400W Model NO.EC-416C Power:400W Working model:Light control, time control, remote control (can be customized with radar) LifePO4 battery:3.2V 24000mAh Solar Panel:6v30W 530*350*18MM LED house size:288*365*80mm light source:Epistar Chip 416pcs 5730 beads IP:IP67 Charge time:5-6hours Discharge time:12-16hours Battery Working Temperature: (-10°C) -60°C Liminous flux:20000lm Beam Angle:120° install height:5-7m irradiated area:200-240㎡ Lamp holder carton:59*41.5*40CM,22KG (10pcs/ctn) Solar Panel packing:56*29.5*38.5CM 25KG (10pcs/ctn)</p>
<p>EC-800C</p>		<p>Light control, time control, remote control (can be customized with radar)</p>	<p>Product name:Solar Flood light 800W Model NO.EC-800C Power:800W Working model:Light control, time control, remote control (can be customized with radar) LifePO4 battery:3.2V 36000mAh Solar Panel:6v40W 600*350*18MM LED house size:449*357*110mm light source:Epistar Chip 800pcs 5730 beads IP:IP67 Charge time:5-6hours Discharge time:12-16hours Battery Working Temperature: (-10°C) -60°C Liminous flux:30000lm Beam Angle:120° install height:6-8m irradiated area:240-300㎡ Lamp holder carton:56.5*49.5*39CM,25KG (10pcs/ctn) Solar Panel packing:56*29.5*38.5CM 24KG (10pcs/ctn)</p>

EC-100F		<p>Light control, time control, remote control</p>	<p>Product name:Solar Flood light 100W Model NO.EC-100F Power:100W Working model:Light control, time control, remote control LifePO4 battery:3.2V 6000mAh Solar Panel:6v10W 235*350*18MM LED house size:185*163*50mm light source:Epistar Chip 128pcs 2835 beads IP:IP65 Charge time:5-6hours Discharge time:12hours+ Battery Working Temperature: (-10°C) -60°C Liminous flux:10000lm Beam Angle:120° install height:4-6m irradiated area:60-80㎡ Lamp holder carton:175*208*54CM, (40pcs/ctn) Solar Panel packing:56*36.5*43.5CM (20pcs/ctn)</p>
EC-200F		<p>Light control, time control, remote control</p>	<p>Product name:Solar Flood light 200W Model NO.EC-200F Power:200W Working model:Light control, time control, remote control LifePO4 battery:3.2V 12000mAh Solar Panel:6v15W 300*350*18MM LED house size:237*240*55mm light source:Epistar Chip 200pcs 2835 beads IP:IP65 Charge time:5-6hours Discharge time:12hours+ Battery Working Temperature: (-10°C) -60°C Liminous flux:20000lm Beam Angle:120° install height:5-7m irradiated area:80-100㎡ Lamp holder carton:46.5*31.5*55.5CM, (20pcs/ctn) Solar Panel packing:32*28*38CM (10pcs/ctn)</p>
EC-300F		<p>Light control, time control, remote control (can be customized with radar)</p>	<p>Product name:Solar Flood light 200W Model NO.EC-300F Power:300W Working model:Light control, time control, remote control LifePO4 battery:3.2V 24000mAh Solar Panel:6v30W 530*350*18MM LED house size:290*250*55mm light source:Epistar Chip 312pcs 2835 beads IP:IP65 Charge time:5-6hours Discharge time:12hours+ Battery Working Temperature: (-10°C) -60°C Liminous flux:30000lm Beam Angle:120° install height:6-8m irradiated area:100-120㎡ Lamp holder carton:55*30.5*33.5CM, (10pcs/ctn) Solar Panel packing:55*30*38CM (10pcs/ctn)</p>
EC-400F		<p>Light control, time control, remote control (can be customized with radar)</p>	<p>Product name:Solar Flood light 200W Model NO.EC-400F Power:400W Working model:Light control, time control, remote control LifePO4 battery:3.2V 36000mAh Solar Panel:6v35W 580*350*18MM LED house size:394*330*55mm light source:Epistar Chip 420pcs 2835 beads IP:IP65 Charge time:5-6hours Discharge time:12hours+ Battery Working Temperature: (-10°C) -60°C Liminous flux:40000lm Beam Angle:120° install height:6-9m irradiated area:120-150㎡ Lamp holder carton:65*32.5*39CM, (10pcs/ctn) Solar Panel packing:63*30*38CM (10pcs/ctn)</p>

<p>EC-100E</p>		<p>Light control, time control, remote control</p>	<p>Product name:Solar Flood light 100W Model NO.EC-100E Power:100W Working model:Light control, time control, remote control LifePO4 battery:3.2V 6000mAh Solar Panel:6v10W 270*180*18MM LED house size:185*163*50mm light source:Epistar Chip 110pcs 2835 beads IP:IP65 Charge time:5-6hours Discharge time:12hours+ Battery Working Temperature: (-10°C) -60°C Liminous flux:10000lm Beam Angle:120° install height:4-6m irradiated area:60-80㎡ Lamp holder carton:56*36*43CM, (40pcs/ctn) Solar Panel packing:33*31*41CM (20pcs/ctn)</p>
<p>EC-200E</p>		<p>Light control, time control, remote control (can be customized with radar)</p>	<p>Product name:Solar Flood light 100W Model NO.EC-200E Power:200W Working model:Light control, time control, remote control LifePO4 battery:3.2V 12000mAh Solar Panel:6v15W 300*350*18MM LED house size:237*240*55mm light source:Epistar Chip 150pcs 2835 beads IP:IP65 Charge time:5-6hours Discharge time:12hours+ Battery Working Temperature: (-10°C) -60°C Liminous flux:10000lm Beam Angle:120° install height:5-7m irradiated area:80-100㎡ Lamp holder carton:46.5*31.5*55.5CM, (20pcs/ctn) Solar Panel packing:32*28*38CM (10pcs/ctn)</p>
<p>EC-300E</p>		<p>Light control, time control, remote control (can be customized with radar)</p>	<p>Product name:Solar Flood light 200W Model NO.EC-300E Power:300W Working model:Light control, time control, remote control LifePO4 battery:3.2V 24000mAh Solar Panel:6v30W 530*350*18MM LED house size:290*250*55mm light source:Epistar Chip 360pcs 2835 beads IP:IP65 Charge time:5-6hours Discharge time:12hours+ Battery Working Temperature: (-10°C) -60°C Liminous flux:30000lm Beam Angle:120° install height:6-8m irradiated area:100-120㎡ Lamp holder carton:55*30.5*33.5CM, (10pcs/ctn) Solar Panel packing:55*30*38CM (10pcs/ctn)</p>
<p>EC-400E</p>		<p>Light control, time control, remote control (can be customized with radar)</p>	<p>Product name:Solar Flood light 200W Model NO.EC-400E Power:400W Working model:Light control, time control, remote control LifePO4 battery:3.2V 36000mAh Solar Panel:6v35W 580*350*18MM LED house size:394*330*55mm light source:Epistar Chip 528pcs 2835 beads IP:IP65 Charge time:5-6hours Discharge time:12hours+ Battery Working Temperature: (-10°C) -60°C Liminous flux:40000lm Beam Angle:120° install height:6-9m irradiated area:120-150㎡ Lamp holder carton:65*32.5*39CM, (10pcs/ctn) Solar Panel packing:63*30*38CM (10pcs/ctn)</p>

<p>EC-03(40w)</p>		<p>Light control, time control, remote control (PIR sense)</p>	<p>Product name:Solar Flood light 40W PIR sense Model NO.EC-03 Power:40W Working model:Light control, time control, remote control LifePO4 battery:3.2V 6000mAh Solar Panel:6v6W 280*185*18MM LED house size:198*188*46mm light source:Epistar Chip 40pcs 2835 beads IP:IP67 Charge time:5-6hours Discharge time:12hours+ Battery Working Temperature: (-10°C) -60°C Liminous flux:4000lm Beam Angle:120° install height:3-4m irradiated area:120-150m² Carton:27*21.8*6.7CM, 1.9KG</p>
<p>EC-080(100w)</p>		<p>Light control, time control, remote control</p>	<p>Product name:Solar Flood light 100W Model NO.EC-080 Power:100W Working model:Light control, time control, remote control LifePO4 battery:3.2V 12000mAh Solar Panel:6v20W 350*350*18MM LED house size:190*170*55mm light source:Epistar Chip 160pcs 2835 beads IP:IP67 Charge time:5-6hours Discharge time:12hours+ Battery Working Temperature: (-10°C) -60°C Liminous flux:20000lm Beam Angle:120° install height:4- 6m irradiated area:100-120m² Color carton:56*41*37.5CM, (5pcs/ctn)</p>
<p>EC-150(200w)</p>		<p>Light control, time control, remote control (can be customized with radar)</p>	<p>Product name:Solar Flood light 200W Model NO.EC-150 Power:200W Working model:Light control, time control, remote control LifePO4 battery:3.2V 18000mAh Solar Panel:6v25W 450*350*18MM LED house size:235*180*55mm light source:Epistar Chip 288pcs 2835 beads IP:IP67 Charge time:5-6hours Discharge time:12hours+ Battery Working Temperature: (-10°C) -60°C Liminous flux:20000lm Beam Angle:120° install height:4- 6m irradiated area:100-120m² Color carton:56*41*37.5CM,19kg (5pcs/ctn)</p>
<p>EC-240(300w)</p>		<p>Light control, time control, remote control (can be customized with radar)</p>	<p>Product name:Solar Flood light 300W Model NO.EC-240 Power:300W Working model:Light control, time control, remote control LifePO4 battery:3.2V 30000mAh Solar Panel:6v35W 530*350*18MM LED house size:290*235*55mm light source:Epistar Chip 288pcs 2835 beads IP:IP67 Charge time:5-6hours Discharge time:12hours+ Battery Working Temperature: (-10°C) -60°C Liminous flux:30000lm Beam Angle:120° install height:5-8m irradiated area:120-140m² Color carton:56*41*38CM,19kg (4pcs/ctn)</p>
<p>EC-816(400w)</p>		<p>Light control, time control, remote control (can be customized with radar)</p>	<p>Product name:Solar Flood light 400W Model NO.EC-816 Power:400W Working model:Light control, time control, remote control LifePO4 battery:3.2V 36000mAh Solar Panel:6v45W 700*350*18MM LED house size:363*260*56mm light source:Epistar Chip 288pcs 2835 beads IP:IP67 Charge time:5-6hours Discharge time:12hours+ Battery Working Temperature: (-10°C) -60°C Liminous flux:30000lm Beam Angle:120° install height:5- 8m irradiated area:120-140m² Color carton:56*32*38.2CM,19kg (4pcs/ctn)</p>





EC-50(50w)		Light control+remote control	<p>Product name:Solar Flood light 50W Model NO.EC-50 Power:50W Working model:Light control +remote control LifePO4 battery:3.2V 12000mAh Solar Panel:6v12W 350*300*18MM LED house size:240*180*83mm Die cast aluminum + glass light source: Bridgelux Chip 82pcs 2835 beads IP:IP67 Charge time:5-6hours Discharge time:12hours+ Battery Working Temperature: (-10°C) -60°C Luminous flux:5000lm Beam Angle:120° install height:4-5m irradiated area:50-60㎡ Color carton:56*32*38.3CM,8kg (8pcs/ctn)</p>
EC-100		Light control+remote control	<p>Product name:Solar Flood light 100W Model NO.EC-100 Power:100W Working model:Light control +remote control LifePO4 battery:3.2V 18000mAh Solar Panel:6v25W 460*350*18MM LED house size:260*200*83mm Die cast aluminum + glass light source: Bridgelux Chip 110pcs 2835 beads IP:IP67 Charge time:5-6hours Discharge time:12hours+ Battery Working Temperature: (-10°C) -60°C Luminous flux:5000lm Beam Angle:120° install height:4-6m irradiated area:60-80㎡ Color carton:50*45*38CM,10kg (5pcs/ctn)</p>
EC-200		Light control+remote control	<p>Product name:Solar Flood light 200W Model NO.EC-200 Power:200W Working model:Light control +remote control LifePO4 battery:3.2V 24000mAh Solar Panel:6v25W 530*350*18MM LED house size:300*240*83mm Die cast aluminum + glass light source: Bridgelux Chip 142pcs 2835 beads IP:IP67 Charge time:5-6hours Discharge time:12hours+ Battery Working Temperature: (-10°C) -60°C Luminous flux:20000lm Beam Angle:120° install height:5-7m irradiated area:100-120㎡ Color carton:39.5*64*12.6CM Out ctn 66.5x39.5x42cm (3pcs/ctn) 5.3kg/pcs</p>
EC-300		Light control+remote control	<p>Product name:Solar Flood light 300W Model NO.EC-300 Power:300W Working model:Light control +remote control LifePO4 battery:3.2V 36000mAh Solar Panel:6v35W 600*350*18MM LED house size:360*298*83mm Die cast aluminum + glass light source: Bridgelux Chip 241pcs 2835 beads IP:IP67 Charge time:5-6hours Discharge time:12hours+ Battery Working Temperature: (-10°C) -60°C Luminous flux:30000lm Beam Angle:120° install height:5-7m irradiated area:100-120㎡ Color carton:39.5*64*12.6CM Out ctn 66.5x39.5x42cm (3pcs/ctn) 5.3kg/pcs</p>
EC-100B		Light control+remote control	<p>Product name:Solar Flood light double 100W Model NO.EC-100B Power:100W Working model:Light control +remote control LifePO4 battery:3.2V 12000mAhx2 Solar Panel:6v35W 600*350*18MM LED house size:360*298*83mm Die cast aluminum + glass light source: Bridgelux Chip 82pcs 2835 beadsx2 IP:IP67 Charge time:5-6hours Discharge time:12hours+ Battery Working Temperature: (-10°C) -60°C Luminous flux:10000lm Beam Angle:120° install height:5-7m irradiated area:80-100㎡ Color carton:52.5*39.5*12.6CM Out ctn 56x39.5x42cm (3pcs/ctn) 3.9kg/pcs</p>

<p>EC-100C</p>		<p>Light control +time control+remote control</p>	<p>Product name:Solar Flood light 100W Model NO.EC-100C Power:100W Working model:Light control +time control+remote control LifePO4 battery:3.2V 18000mAh Solar Panel:6v20W 350*350*64MM LED house size:206*255*83mm Die cast aluminum + glass light source: Bridgelux Chip 110pcs 2835 beads IP:IP67 Charge time:5-6hours Discharge time:12hours+ Battery Working Temperature: (-10°C) -60°C Liminous flux:10000lm Beam Angle:120° install height:5-6m irradiated area:100-120m² Out ctn led 450*375*310mm (5pcs) out ctn solar panel 375*380*280mm (10pcs)</p>
<p>EC-200C</p>		<p>Light control +time control+remote control</p>	<p>Product name:Solar Flood light 200W Model NO.EC-200C Power:200W Working model:Light control +time control+remote control LifePO4 battery:3.2V 18000mAh Solar Panel:6v25W 450*350*18mm LED house size:206*255*83mm Die cast aluminum + glass light source: Epistar Chip 110pcs 2835 beads IP:IP67 Charge time:5-6hours Discharge time:12hours+ Battery Working Temperature: (-10°C) -60°C Liminous flux:10000lm Beam Angle:120° install height:5-7m irradiated area:120-140m² 450*375*310mm (5pcs) out ctn solar panel 375*380*280mm (10pcs)</p>
<p>EC-300C</p>		<p>Light control +time control+remote control</p>	<p>Product name:Solar Flood light 300W Model NO.EC-300C Power:300W Working model:Light control +time control+remote control LifePO4 battery:3.2V 24000mAh Solar Panel:6v25W 530*350*78mm LED house size:268*335*83mm Die cast aluminum + glass light source: Epistar Chip 854pcs 2835 beads IP:IP67 Charge time:5-6hours Discharge time:12hours+ Battery Working Temperature: (-10°C) -60°C Liminous flux:10000lm Beam Angle:120° install height:5-8m irradiated area:140-160m² 450*375*310mm (5pcs) 550*300*380mm (10pcs) out ctn solar panel 375*380*280mm (10pcs)</p>
<p>EC-800C</p>		<p>Light control +time control+remote control</p>	<p>Product name:Solar Flood light 400W Model NO.EC-400C Power:300W Working model:Light control +time control+remote control LifePO4 battery:3.2V 30000mAh Solar Panel:6v25W 580*350*78mm LED house size:400*350*85mm Die cast aluminum + glass light source: Epistar Chip 1506pcs 2835 beads IP:IP67 Charge time:5-6hours Discharge time:12hours+ Battery Working Temperature: (-10°C) -60°C Liminous flux:10000lm Beam Angle:120° install height:5-8m irradiated area:140-160m² 495*415*370mm (5pcs) 630*380*300mm (10pcs)</p>

NO	Product	Model	Photo	Description	Packing Quantity(pcs)	Carton Size	GW weight
SOLAR FLOOD LIGHT WITH CAMERA							
1	Transformer 100W (with camera)	MJ-DW901		[battery] lithium iron phosphate 12Ah [photovoltaic panel] A-level polycrystalline silicon 5V/20W (350*350mm) [number of lamp beads] 82 pcs [mirror head] 2 million pixels [discharge time] 2 cloudy or rainy days [Function] Intelligent light control for 4 hrs+radar model [lamp body size] 217*179*45mm [irradiation area] 80 square meters [product configuration] waterproof wire/u-frame/remote control/screw	8	66*37.5*38	19.5
2	Transformer 200W (with camera)	MJ-DW902		[battery] lithium iron phosphate 24Ah [photovoltaic panel] A-level polycrystalline silicon 5V/28W (530*350mm) [number of lamp beads] 144 pcs [mirror head] 2 million pixels [discharge time] 2 cloudy or rainy days [Function] Intelligent light control for 4 hrs+radar model [lamp body size] 258*213*45mm [irradiation area] 150 square meters [product configuration] waterproof wire/u-frame/remote control/screw	6	56*52.5*39	24
3	Transformer 300W (with camera)	MJ-DW903		[battery] lithium iron phosphate 30Ah [photovoltaic panel] A-level polycrystalline silicon 5V/28W (580*350mm) [number of lamp beads] 236 pcs [mirror head] 2 million pixels [discharge time] 2 cloudy or rainy days [Function] Intelligent light control for 4 hrs+radar model [lamp body size] 312*270*50mm [irradiation area] 200 square meters [product configuration] waterproof wire/u-frame/remote control/screw	5	60.5*46*39	23.5
4	Transformer 400W (with camera)	MJ-DW904		[battery] lithium iron phosphate 42Ah [photovoltaic panel] A-level polycrystalline silicon 5V/40W (630*350mm) [number of lamp beads] 324 pcs [mirror head] 2 million pixels [discharge time] 2 cloudy or rainy days [Function] Intelligent light control for 4 hrs+radar model [lamp body size] 365*295*50mm [irradiation area] 300 square meters [product configuration] waterproof wire/u-frame/remote control/screw	4	66*37*39	21
TF SOLAR FLOOD LIGHT (WITHOUT CAMERA)							
5	Transformer 100W	MJ-D901-1		[Battery] Lithium iron phosphate 6Ah [Photovoltaic panel] 5V/10W (350*235mm) [Number of beads] 82 pcs 2835 high-brightness beads [Lamp body size] 217*179*45mm [Discharge time] about 18 hours [irradiation area] 80 square meters [Function] Intelligent Optical Control + Remote Control [Product Configuration] Waterproof Line/ U Frame/Remote Controller/Screw	10	74*42*26.5	17
6	Transformer 100W	MJ-D901-2		[Battery] Lithium iron phosphate 12Ah [Photovoltaic panel] 5V/15W (350*300mm) [Number of beads] 82 pcs 2835 high-brightness beads [Lamp body size] 217*179*45mm [Discharge time] about 18 hours [irradiation area] 80 square meters [Function] Intelligent Optical Control + Remote Control [Product Configuration] Waterproof Line/ U Frame/Remote Controller/Screw	8	66*37.5*32	18

7	Transformer 200W	MJ-D902		[Battery] Lithium iron phosphate 18Ah [Photovoltaic panel] 5V/25W (430*350mm) [Number of beads] 144 pcs 2835 high-brightness beads [Lamp body size] 258*213*45mm [Discharge time] about 18 hours [irradiation area] 150 square meters [Function] Intelligent Optical Control + Remote Control [Product Configuration] Waterproof Line/ U Frame/Remote Controller/Screw	7	58*45.5*38	25.5
8	Transformer 300W	MJ-D903		[Battery] Lithium iron phosphate 24Ah [Photovoltaic panel] 5V/28W (500*350mm) [Number of beads] 236 pcs 2835 high-brightness beads [Lamp body size] 312*270*50mm [Discharge time] about 18 hours [irradiation area] 200 square meters [Function] Intelligent Optical Control + Remote Control [Product Configuration] Waterproof Line/ U Frame/Remote Controller/Screw	6	56*52.5*39	24
9	Transformer 400W	MJ-D904-1		[Battery] Lithium iron phosphate 30Ah [Photovoltaic panel] 5V/35W (580*350mm) [Number of beads] 324 pcs 2835 high-brightness beads [Lamp body size] 365*295*50mm [Discharge time] about 18 hours [irradiation area] 300 square meters [Function] Intelligent Optical Control + Remote Control [Product Configuration] Waterproof Line/ U Frame/Remote Controller/Screw	5	60.5*46*39	23.5
10	Transformer 600W	MJ-D904-2		[Battery] Lithium iron phosphate 36Ah [Photovoltaic panel] 5V/40W (580*350mm) [Number of beads] 324 pcs 3030 high-brightness beads [Lamp body size] 365*295*50mm [Discharge time] about 18 hours [irradiation area] 300 square meters [Function] Intelligent Optical Control + Remote Control [Product Configuration] Waterproof Line/ U Frame/Remote Controller/Screw	4	66*37*39	21
INTERSTELLAR WARRIOR SOLAR STREET LAMP							
11	Interstellar Warrior 100W	XJ801		[Battery] lithium iron phosphate 18Ah [Photovoltaic panels] 5V/25W (430*350mm) [Number of beads] 192 pcs 2835high-brightness beads [Lamp size] 520*260*80mm [Discharge time] about 18 hours [Function] Intelligent Optical Control + Remote Control [Product Configuration] Waterproof Line/ U Frame/Lamp Arm/Remote Controller/Screw	4	59*55*42	24.8
12	Interstellar Warrior 200W	XJ802		[Battery] lithium iron phosphate 30Ah [Photovoltaic panels] 5V/35W (580*350mm) [Number of beads] 192 pcs 2835high-brightness beads [Lamp size] 520*260*80mm [Discharge time] about 18 hours [Function] Intelligent Optical Control + Remote Control [Product Configuration] Waterproof Line/ U Frame/Lamp Arm/Remote Controller/Screw	4	64*55*42	27.4
13	Interstellar Warrior 300W	XJ803		[Battery] lithium iron phosphate 36Ah [Photovoltaic panels] 5V/40W (630*350mm) [Number of beads] 300 pcs 2835high-brightness beads [Lamp size] 600*300*80mm [Discharge time] 2 days [Function] Intelligent Optical Control + Remote Control [Product Configuration] Waterproof Line/ U Frame/Lamp Arm/Remote Controller/Screw	3	71.5*41*44	23.6
14	Interstellar Warrior 400W	XJ804		[Battery] lithium iron phosphate 48Ah [Photovoltaic panels] 5V/48W (670*445mm) [Number of beads] 300 pcs 2835high-brightness beads [Lamp size] 600*300*80mm [Discharge time] 2 days [Function] Intelligent Optical Control + Remote Control [Product Configuration] Waterproof Line/ U Frame/Lamp Arm/Remote Controller/Screw	2	73*30*52	18.6

INTREPID PIONEER ALL IN ONE SOLAR STREET LIGHT

15	Intrepid Pioneer 100W	LH8100		Battery:lithium iron phosphate 12Ah Photovoltaic panels: 4V/10W (420*210mm) Number of beads: 360 pcs 2835high-brightness beads Lamp body size: 530*270*70mm Discharge time: 3days Irradiation area: 60 square meters Function: Intelligent Optical Control + Remote Control+Radar Sensors Product Configuration: Remote Controller	5	56*38*30	12
16	Intrepid Pioneer 200W	LH8200		Battery:lithium iron phosphate 18Ah Photovoltaic panels: 4V/15W (535*210mm) Number of beads: 480 pcs 2835high-brightness beads Lamp body size: 645*300*70mm Discharge time: 3days Irradiation area: 100 square meters Function: Intelligent Optical Control + Remote Control+Radar Sensors Product Configuration: Remote Controller	5	67*38*33	14.8
17	Intrepid Pioneer 300W	LH8300		Battery:lithium iron phosphate 24Ah Photovoltaic panels: 4V/18W (635*210mm) Number of beads: 600 pcs 2835high-brightness beads Lamp body size: 750*300*70mm Discharge time: 3days irradiation area: 150 square meters Function: Intelligent Optical Control + Remote Control+Radar Sensors Product Configuration: Remote Controller	5	78*38*33	17.75
18	Lamp Arm and Screws				30	55*40*40	22.5

Solar Power KIT

Model	EC-1212		Picture
Solar Panel Power	18V/10Wp	18V/20Wp	
Gel battery Capacity	12V/7AH	12V/12AH	
Solar Controller	12V/5A		
DC output	(12V/5A) 3pcs., (USB 5V/2A) 2pcs		
Shell Material	1.0MM Cold plate, Surface spray powder treatment		
Produce Size	21.5CM*12CM*10.5CM		
Electric Qty display light	Yes		
Accessories	1 main machine, 1 solar panel, 1 battery, 2 pcs 3W led bulb, 1 manual		
Packing			
Packing weight	5.7KG/set	6.5KG/set	
ckage size of host machine (M	main machine : 250*175*210 Outside boxes : 375*270*450 (4set/box)		
Solar panel packing size (MM)	245*360*25	430*360*25	
			Applications:DC LED bulb lighting, mobile phone charging, DC small fan and other DC

Model	EC-1220 (Lead-acid batteries)		Picture
Solar Panel Power	18V/30Wp	18V/50Wp	
Gel battery Capacity	12V/17AH	12V/20AH	
Solar Controller	12V/10A		
DC output	(12V/5A) 4pcs., (USB 5V/2A) 2pcs		
AC output	modified300W(220V/110Voptional)		
Shell Material	1.0MM Cold plate, Surface spray powder treatment		
Produce Size	30CM*12.7CM*24CM		
Electric Qty display light	Yes		
Accessories	1 main machine, 1 solar panel, 1 battery, 2 pcs 3W led bulb, 1 manual		
Packing			
Box Packing(MM)	Packing size : 350*176*287		
Solar panel packing size (MM)	505*440*30	740*530*30	
Packing weight	11KG/set	14KG/set	
			Applications:DC LED lamp, mobile phone, LCD TV, notebook, small fan, satellite

Model	ZL-1212		Picture
Solar Panel Power	18V/10Wp	18V/20Wp	
Gel battery Capacity	12V/7AH	12V/12AH	
Solar Controller	12V/5A		
DC output	(12V/5A) 3pcs., (USB 5V/2A) 2pcs		
Shell Material	1.0MM Cold plate, Surface spray powder treatment		
Produce Size	21.5CM*12CM*10.5CM		
Electric Qty display light	Yes		
Accessories	1 main machine, 1 solar panel, 1 battery, 2 pcs 3W led bulb, 1 manual		
Packing			
Packing weight	5.7KG/set	6.5KG/set	
Package size (MM)	Box size : 250*175*210 outside box : 375*270*450 (4set/box)		
Solar panel packing size (MM)	245*360*25	430*360*25	
			Applications: : DC LED bulb lighting, mobile phone charging, DC small fan and other DC

Model	ZL-1240			Picture
Solar Panel Power	18V/30Wp	18V/50Wp	18V/80Wp	
Gel battery Capacity	12V/17AH	12V/24AH	12V/40AH	
Solar Controller	12V/10A			
DC output	(12V/8A) 4pcs., (USB 5V/1.5A) 4pcs			
Shell Material	1.0MM Cold plate, Surface spray powder treatment			
Produce Size	27CM*20CM*27CM			
Electric Qty display light	Yes			
accessories	1 main machine, 1 solar panel, 1 battery, 2 pcs 3W led bulb, 1 manual			
Packing				
Box size(MM)	packaging : 380*260*300			
Solar panel packing size (MM)	505*440*30	740*530*30	1010*520*40	
Packing weight	12KG/set/0.04CBM	18KG/set 0.045CBM	25KG/set 0.054CBM	
				Applications: : DC LED bulb lighting, mobile phone charging, DC TV, DC fans and other

Model	JL-1224			Picture
Solar Panel Power	18V/50Wp	18V/80Wp		
Gel battery Capacity	12V/24AH	12V/40AH		
Solar Controller	12V/10A			
DC output	(12V/5A) 4pcs., (USB 5V/2A) 2pcs			
AC output	Modified 300W(220V/110Voptional); Pure +15USD			
Shell Material	1.0MM Cold plate, Surface spray powder treatment			
Produce Size	31CM*20CM*26.5CM			
Electric Qty display light	Yes			
Accessories	1 main machine, 1 solar panel, 1 battery, 2 pcs 3W led bulb, 1 manual			
Packing				
Box size(MM)	380*260*300			
Solar panel packing size (MM)	740*530*30		1010*520*40	
Packing weight	19KG/set		26KG/set	
				Applications: : DC LED lamp, mobile phone, LCD TV, notebook, small fan, satellite receiver, audio combination, etc

Model	LD-12T			Picture
Solar Panel Power	18V/50Wp	18V/100Wp		
Li battery Capacity	12V/20AH	12V/40AH		
Solar Controller	12V/10A/PWM			
DC output	(12V/5A) 4pcs., (USB 5V/2A) 4pcs			
AC output	Pure 300W(220V/110Voptional)			
Shell Material	1.0MM Cold plate, Surface spray powder treatment			
Produce Size	30.5CM*18.5CM*21CM			
Electric Qty display light	Yes			
Accessories	1 main machine, 1 solar panel, 1 battery, 2 pcs 3W led bulb, 1 manual			
Packing				
Box size(MM)	Box size : 365*250*260			
Solar panel packing size (MM)	740*530*30		1020*700*55	
Packing weight	11KG/set		19KG/set	
				Applications: : DC LED lamp, mobile phone, LCD TV, computer, fluorescent printer, fan, satellite receiver, combination audio, etc

[Click to Homepage](#)

Model	ZL-USB	Picture
Solar Panel Power	18V/80Wp	
凝胶Gel battery Capacity	12V/40AH	
Solar Controller	12V/10A	
DC output	(12V/5A) 4pcs、(USB 5V/2A) 10pcs	
Shell Material	1.0MM Cold plate、Surface spray powder treatment	
Produce Size	27CM*20CM*27CM	
Electric Qty display light	Yes	
Accessories	1 main machine, 1 solar panel, 1 battery, 2 pcs 3W led bulb, 1 manual	
Packing		
Box size(MM)	380*260*300	
Solar panel packing size (MM)	1010*520*40	
Packing weight	26KG/set	
		Applications: : DC LED lamp, mobile phone, DC LCD TV, DC fan

Model	LD-1000	Picture
Solar Panel Power	18V/100Wp 18V/200Wp	
Li battery Capacity	12V/40AH 12V/80AH	
Solar Controller	12V/15A/PWM	
DC output	(12V/5A) 4pcs、(USB 5V/2A) 4pcs、(12V/10A) 1pcs	
AC输出	Pure 500W(220V/110Voptional) Pure 1000W(220V/110Voptional)	
Shell Material	1.0MM Cold plate、Surface spray powder treatment	
Produce Size	34CM*21CM*30CM	
Electric Qty display light	Yes	
Accessories	1 main machine, 1 solar panel, 1 battery, 2 pcs 5W led bulb, 1 manual	
Packing		
Box size(MM)	Box size : 430*250*365	
Solar panel packing size (MM)	1020*700*55 1020*700*110	
Packing weight	19KG/set 29KG/set	
		Applications: : DC LED lamp, mobile phone, LCD TV, computer, fluorescent printer, fan,

Model	YJ-12100	Picture
Solar Panel Power	18V/100Wp*2PCS (poly)	
凝胶Gel battery Capacity	12V/100AH	
Solar Controller	12V/15A	
DC output	(12V/8A) 8pcs、(USB 5V/3A) 2pcs	
AC output	Pure 500W	
Shell Material	1.0MM Cold plate、Surface spray powder treatment	
Produce Size	58CM*26CM*44CM	
LCD	Yes	
AC Charge	Yes(optional function)	
Accessories	1 main machine, 1 solar panel, 1 battery, 2 pcs 5W led bulb, 1 manual	
Packing		
Main engine carton size(MM)	650*350*470	
main engine wooden case(MM)	670*320*470	
Solar panel packing size (MM)	1020*700*110	
Packing weight	48KG	
		Applications: : DC LED lamp, mobile phone, LCD TV, notebook, fan, small electric cooker, satellite receiver, combination audio, etc

Model	JLX-24200	Picture
Solar Panel Power	18V/100Wp*4PCS	
凝胶Gel battery Capacity	12V/100AH*2PCS	
Solar Controller	24V/20A	
DC output	(24V/8A) 4pcs、(USB 5V/3A) 2pcs	
AC output	Pure 1000W	
Shell Material	1.0MM Cold plate、Surface spray powder treatment	
Produce Size	55CM*45CM*52CM	
Electric Qty display light	Yes	
AC Charge	Yes	
Accessories	1 main machine, 1 solar panel, 2pcs battery, 2 pcs 5W led bulb, 1 manual	
Packing		
Wooden case packing size(MM)	740*520*700	
Solar panel packing size (MM)	1020*700*220	
Packing weight	94kg	
		Applications: : DC LED lamp, mobile phone, LCD TV, notebook, fan, rice cooker, refrigerator, satellite receiver, combination

Model	EC-1212LI	Picture
Solar Panel Power	18V/10Wp 18V/20Wp 18V/30Wp 18V/50Wp	
Li battery Capacity	12V/4AH 12V/8AH 12V/12AH 12V/18AH	
Solar Controller	12V/5A	
DC output	(12V/5A) 3pcs, (USB 5V/2A) 2pcs	
Shell Material	1.0MM Cold plate, Surface spray powder treatment	
Produce Size	21.5CM*12CM*10.5CM	
Electric Qty display light	Yes	
Accessories	1 main machine, 1 solar panel, 1 battery, 2 pcs 3W led bulb, 1 manual	
Packing		
Packing weight	3KG/set 5KG/set 7KG/set 9KG/set	
Package size of host machine (mm)	host machine size : 250*175*210mm outside box size : 375*270*450 (4set/box)	
Solar panel packing size (MM)	245*360*25 430*360*25 505*440*30 740*530*30	
		Applications:DC LED bulb lighting, mobile phone charging, DC small fan and other DC

Model	EC-1220 Lithium battery model	Picture
Solar Panel Power	18V/30Wp 18V/50Wp 18V/100Wp	
Li battery Capacity	12V/12AH 12V/20AH 12V/40AH	
Solar Controller	12V/10A	
DC output	(12V/5A) 4pcs, (USB 5V/2A) 2pcs	
AC output	modified150W(220V/110V optional) modified300W(220V/110V optional)	
Shell Material	1.0MM Cold plate, Surface spray powder treatment	
Produce Size	30CM*12.7CM*24CM	
Electric Qty display light	Yes	
Accessories	1 main machine, 1 solar panel, 1 battery, 2 pcs 3W led bulb, 1 manual	
Packing		
box size(MM)	packaging : 350*176*287	
Solar panel packing size (MM)	505*440*30 740*530*30 1020*700*55	
Packing weight	8KG/set 10KG/set 16KG/set	
		Applications:DC LED lamp, mobile phone, LCD TV, notebook, small fan, satellite receiver, audio

Model	ZL-1212	Picture
Solar Panel Power	18V/10Wp 18V/20Wp 18V/30Wp 18V/50Wp	
Li battery Capacity	12V/4AH 12V/8AH 12V/12AH 12V/18AH	
Solar Controller	12V/5A	
DC output	(12V/5A) 3pcs, (USB 5V/2A) 2pcs	
Shell Material	1.0MM Cold plate, Surface spray powder treatment	
Produce Size	21.5CM*12CM*10.5CM	
Electric Qty display light	Yes	
Accessories	1 main machine, 1 solar panel, 1 battery, 2 pcs 3W led bulb, 1 manual	
Packing		
Packing weight	4KG/set 5KG/set 7KG/set 7KG/set	
Package size of host machine (mm)	Box size : 250*175*210 outside : 375*270*450 (4set/box)	
Solar panel packing size (MM)	245*360*25 430*360*25 505*440*30 740*530*30	
		Applications: DC LED bulb lighting, mobile phone charging, DC small fan and other DC

Model	DL-1224	Picture
Solar Panel Power	18V/50Wp 18V/80Wp	
Gel battery Capacity	12V/24AH 12V/40AH	
Solar Controller	12V/10A	
DC output	(12V/5A) 4pcs, (USB 5V/2A) 4pcs	
AC output	modified300W(220V/110V optional) ;Pure +15USD	
Shell Material	1.0MM Cold plate, Surface spray powder treatment	
Produce Size	31CM*20CM*26.5CM	
Electric Qty display light	Yes	
Accessories	1 main machine, 1 solar panel, 1 battery, 2 pcs 3W led bulb, 1 manual	
Packing		
Box size(MM)	380*260*300	
Solar panel packing size (MM)	740*530*30 1010*520*40	
Packing weight	19KG/set 26KG/set	
		Applications: DC LED lamp, mobile phone, LCD TV, notebook, small fan, satellite

Solar Power Pump Quotation

3inch SCREW SOLAR PUMP WITH S/S inlet/outlet							Picture
Mod el	Power	Voltage	Max flow (m3/h)	Max head (m)	Outlet (inch)	solar panels	
3DSS0.5-28-12-80	80	12	0.5	28	0.75"	1pc 100w	
3DSS1.2-56-24-120	120	24	1.2	56	0.75"	1pc 200w	
3DSS1.2-77-36-210	210	36	1.2	77	0.75"	1pc 300w	
3DSS1.7-109-48-500	500	48	1.7	109	0.75"	2pcs 315w	

3inch SOLAR PUMP WITH PLASTIC IMPELLER							Picture
Mod el	Power	Voltage	Max flow (m3/h)	Max head (m)	Outlet (inch)	solar panles	
3DPC3-25-24-200	200	24	3	25	1	1pc 300w	
3DPC3-47-48-400	600	48	3	47	1.25"	4pcs 260w	
3DPC3-80-48-600	750	48	3	80	1.25"	4pcs 265w	
3DPC3.5-95-72-750	750	72	3.5	95	1.25"	4pcs 260w	
3DPC3.8-123-110-1100	1100	110	3.8	123	1.25"	6pcs 265w	
3DPC3.8-180-110-1500	1500	110	3.8	180	1.25"	8pcs 265w	

4inch SOLAR PUMP WITH PLASTIC IMPELLER							Picture
Mod el	Power	Voltage	Max flow (m3/h)	Max head (m)	Outlet (inch)	solar panles	
4DPC6-42-48-600	600	48	6	42	1.25"	4pcs 260w	
4DPC6-56-72-750	750	48	6	56	1.25"	4pcs 265w	
4DPC6-84-110-1100	1100	110	6	84	1.25"	6pcs 265w	

4DPC6-112-110-1300	1300	110	6	112	1.25"	6pcs 265w
4DPC6-140-110-1500	1500	110	6	140	1.25"	8pcs 265w
4DPC9-58-110-1300	1300	110	9	58	2"	6pcs 265w
4DPC9-71-110-1500	1500	110	10	71	2"	8pcs 265w
4DPC13-60-110-1500	1500	110	13	60	2"	8pcs 265w

4inch Solar pump with 304 S/S impeller								Picture
Model	Power	Voltage	Max flow (m3/h)	Max head (m)	Outlet (inch)	solar paneks		
4DSC5-45-48-500	500	48	5	45	1.25"	2pcs 315w		
4DSC5-67-48-750	750	48	5	67	1.25"	4pcs 265w		
4DSC5-67-72-750	750	72	5	67	1.25"	4pcs 260w		
4DSC5-101-110-1100	1100	110	5	101	1.25"	6pcs 265w		
4DSC5-146-110-1300	1500	110	5	146	1.25"	8pcs 265w		
4DSC7-67-110-1300	1300	110	7	67	1.25"	6pcs 265w		
4DSC7-79-110-1500	1500	110	7	79	1.25"	8pcs 265w		
4DSC9-59-110-1500	1500	110	9	59	1.5"	8pcs 265w		
4DSC4.5-203-110-1500	1500	110	4.5	203	1.25"	8pcs 265w		
4DSC19-34-110-1500	1500	110	19	34	2"	8pcs 265w		
DQ2.0-25-24/210	210	24	2	25	1.0"			

Solar Land Surface pump								Picture
Model	Power	Voltage	Max flow (m3/h)	Max head (m)	Outlet (inch)	solar panles		
DQ2.0-25-24/210	210	24	2	25	1"	2pcs 150w		
DQ2.0-30-24/280	280	24	2	30	1"	2pcs 200w		
DQ3.0-50-48/550	550	48	3	50	1"	4pcs 200w		
DQ3.0-65-72/750	750	72	3	65	1"	4pcs 265w		

Remark: sample price including the pump and mppt controller and 2m cables

1. Permanent magnet DC brushless synchronous motor: The efficiency is improved by 15%-20%; Save energy; Reduce the consumption of solar panels.
2. 304 S/S pump shaft.
3. Brass outlet/connector/ oil cylinder.
4. Japanese NSK bearing, the working life will be 3 to 5 times prolonged.
5. Double bearing motor base can work under more axial pressure
6. Alloy mechanical seal: Longer working life and high reliability.
7. Motor coil is made by automatic winding machine with centralized winding technology, motor efficiency is much improved.
8. Intelligent water shortage protection: The pump stops working automatically when there is no water in the well, and automatically start working 30 minutes
9. 3years warranty
10. MPPT Controller:
 - (1) Waterproof grade: IP65
 - (2) VOC range:
 - 24V controller: 18V-50V;
 - 36V controller: 30V-96V;
 - 48V controller: 30V-96V;
 - 72V controller: 50V-150V;
 - 96V controller: 60V-180V;
 - 110V controller: 60V-180V
 - (3) Ambient temperature: -15°C~60°C
 - (4) Max. input current: 15A
 - (5) MPPT function, the solar power utilization rate is higher.
 - (6) Automatic charging function: Guarantee the pump normally working, meanwhile charge the battery; And when there is no sunshine, the battery can make
 - (7) LED displays the power, voltage, current, speed etc working condition.

(8) Frequency conversion function: It can automatically run with frequency conversion according to the solar power, and user also can change the speed of

(9) Automatically start and stop working.

(10) Water proof and leak-proof: Double seal effect.

(11) Soft start: No impulse current, protect the pump motor.

(12) High voltage/Low voltage/Over-current/High temperature protection 43 / 49

[Back to Homepage](#)

8000W Hybrid Solar Inverter with controller system (UL) USA

NO.	PRODUCT NAME	MODEL NAME	PIC	Description	QTY
1	8KW Hybrid solar inverter with controller	NK-LB8000LNA		inverter rated power:8kw split phase 120/240v . solar input range:125~500Vdc warranty:2years size(mm)430*220*710 weight:41kg	1
	lithium battery with Dc cable	Li-10kwh		brand: Lithium iron phosphate battery /48v10kwh weight:100kg /PCS warranty:2years	1
	41.1V455W MONO	HJT-450M-41		mono solar panel max power:455w current max power:11.07a voltage max power:41.1v size of module(mm)2094*1038*35	12
	CABLES	solar cables,battery cables		PV cable , battery cable plug warranty:5years without ac cable	1
	solar rack	2pcs panel one set		Photovoltaic special galvanized steel bracket 2pcs panel one set warranty:5years	6

10000W Hybrid Solar Inverter with controller system (UL) USA

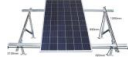
NO.	PRODUCT NAME	MODEL NAME	PIC	Description	QTY
1	10KW Hybrid solar inverter with controller	NK-LB10000LNA		inverter rated power:10kw split phase 120/240v . solar input range:125-500Vdc warranty:2years size(mm)430*220*710 weight:41kg	1
	lithium battery with Dc cable	Li-20kwh		brand: Lithium iron phosphate battery /125-600v20kwh weight:100kg/PCS warranty:2years	1
	41.1V455W MONO	HJT-450M-41		mono solar panel max power:455w current max power:11.07a voltage max power:41.1v size of module(mm)2094*1038*35	22
	CABLES	solar cables,battery cables		PV cable , battery cable plug warranty:5years without ac cable	1
	solar rack	2pcs panel one set		Photovoltaic special galvanized steel bracket 2pcs panel one set warranty:5years	11







5000W Single phase Hybrid Solar Inverter with controller system

NO.	PRODUCT NAME	MODEL NAME	PIC	Description	QTY
1	5KW Hybrid solar inverter with controller	NK-LB5000P1		inverter rated power:5kw single phase 230V /180Vac~280Vac solar input range:125~550Vdc warranty:2years size(mm)550X200X515 weight:25kg	1
	lithium battery with Dc cable	Li-10kwh		brand: Lithium iron phosphate battery /48v10kwh weight:100kg /PCS warranty:2years	1
	41.1V455W MONO	HJT-450M-41		mono solar panel max power:455w current max power:11.07a voltage max power:41.1v size of module(mm)2094*1038*35	12
	CABLES	solar cables,battery cables		PV cable , battery cable plug warranty:5years without ac cable	1
	solar rack	2pcs panel one set		Photovoltaic special galvanized steel bracket 2pcs panel one set warranty:5years	6





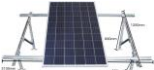

8000W Three phase Hybrid Solar Inverter with controller system

NO.	PRODUCT NAME	MODEL NAME	PIC	Description	QTY
1	8KW Hybrid solar inverter with controller	NK-LB8000P3	 	inverter rated power:8kw three phase 400VAC /360Vac~440Vac solar input range:125~850Vdc warranty:2years size(mm)530X220X565 weight:30kg	1
	lithium battery with Dc cable	Li-20kwh		brand: Lithium iron phosphate battery /256v20kwh weight:200kg/PCS warranty:2years	1
	41.1V455W MONO	HJT-450M-41	 	mono solar panel max power:455w current max power:11.07a voltage max power:41.1v size of module(mm)2094*1038*35	18
	CABLES	solar cables,battery cables		PV cable , battery cable plug warranty:5years without ac cable	1
	solar rack	2pcs panel one set		Photovoltaic special galvanized steel bracket 2pcs panel one set warranty:5years	9

10000W Three phase Hybrid Solar Inverter with controller system

NO.	PRODUCT NAME	MODEL NAME	PIC	Description	QTY
1	10KW Hybrid solar inverter with controller	NK-LB10000P3	 	inverter rated power:10kw three phase 400VAC /360Vac~440Vac solar input range:125~600Vdc warranty:2years size(mm)530X220X565 weight:30kg	1
	lithium battery with Dc cable	Li-20kwh		brand: Lithium iron phosphate battery /256v20kwh weight:200kg /PCS warranty:2years	1
	41.1V455W MONO	HJT-450M-41	 	mono solar panel max power:455w current max power:11.07a voltage max power:41.1v size of module(mm)2094*1038*35	22
	CABLES	solar cables,battery cables		PV cable , battery cable plug warranty:5years without ac cable	1
	solar rack	2pcs panel one set		Photovoltaic special galvanized steel bracket 2pcs panel one set warranty:5years	11

12000W Three phase Hybrid Solar Inverter with controller system

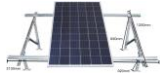
NO.	PRODUCT NAME	MODEL NAME	PIC	Description	QTY
1	12KW Hybrid solar inverter with controller	NK-LB12000P3		inverter inverter rated power:12kw three phase 400VAC /360Vac~440Vac solar input range:125~600Vdc warranty:2years size(mm)530X220X565 weight:30kg	1
	lithium battery with Dc cable	Li-20kwh		brand: Lithium iron phosphate battery /256v20kwh weight:200kg /PCS warranty:2years	1
	41.4V450W MONO	HJT-450M-41		mono solar panel max power:455w current max power:11.07a voltage max power:41.1v size of module(mm)2094*1038*35	26
	BD/BC-158	Freezer		Net Capacity:158L Net Capacity (Fridge/Freezer): 158L Temperature: -18°Cfreezer Compressor: exterior rotor structure Refrigerant:R134a Input Voltage:DC 12V/24V; AC by Adaptor Input Power: 55W Energy Consumption: 55W/Hour Foaming Material: G-pentane, CFC free Temperature controller: Mechanical Body color: White Product Size: 750*555*850mm	1
	BCD-295	Refrigerator		Net Capacity:295L Net Capacity (Fridge/Freezer): 215L+80L Temperature:0~10 °C/ -18°Cfreezer Compressor: exterior rotor structure Refrigerant:R134a Input Voltage:DC 12V/24V; AC by Adaptor Energy Consumption: 125W/Hour Foaming Material: G-pentane, CFC	1
	TV	4K 55inch LED TV (Explosion-proof glass)		55inch LED TV (Explosion-proof glass)4K resolution: 3840x2160 aspect ratio: 16:9 ports:HDMI,USB,1xVGA,TV/AV	1
	CABLES	solar cables,battery cables		PV cable , battery cable plug warranty:5years without ac cable	1
	solar rack	2pcs panel one set		Photovoltaic special galvanized steel bracket 2pcs panel one set warranty:5years	13