

PTi 150/220...240 I

POWERTRONIC INTELLIGENT PTi I | ECG for HID lamps, with cable clamp



Product family features

- Energy Efficiency Index EEI: A2
- Supply voltage: 220...240 V
- Line frequency: 50...60 Hz
- RI suppression: to EN 55015/CISPR 15
- Safety: to EN 61347-2-12
- Line harmonics according to EN 61000-3-2
- Immunity according to EN 61547

Product family benefits

- Extended terminal section enables mains looping
- Screw-down cable clamps for reliable strain relief
- Long reliable life at maximum permitted temperatures
- Automatic safety shutdown of lamps in the event of a defect or at end of life (EoL)

Areas of application

- Shop lighting
- Health and fitness areas (in luminaires with protection class IP66 or higher)
- Effect and accent lighting

Technical data

Electrical data

Lamp wattage	147 W
Maximum output power	147 W
Line current	0.72 A ¹⁾
Ignition voltage	4.5 kVp
Operating frequency	0.165 kHz
System wattage	160.00 W
Efficiency in full-load	92 %
Input voltage AC	198...254 V
Nominal voltage	220...240 V
Mains frequency	50...60 Hz
Power factor λ	0.95 ²⁾
Inrush current	70 A ³⁾
Max. ECG no. on circuit breaker 10 A (B)	4 ⁴⁾
Max. ECG no. on circuit breaker 16 A (B)	7 ⁴⁾
Max. no. of ECGs on 16A MCB with EBN-OS	17 ⁴⁾
Protective conductor current	0.4 mA
U-OUT (working voltage)	250 V
Max. working voltage between LH and LL	250 V
Max. working voltage betw. LL/LH & earth	250 V
Max. capacitance of wire ECG/lamp	120 pF

1) At 230 V_{AC}

2) Minimum

3) $t_{width} = 250 \mu s$ (measured at 50 % I_{peak})

4) Type B

Dimensions & weight

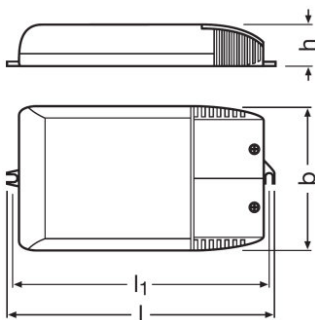

Length	212.0 mm
--------	----------

Product datasheet

Width	93.0 mm
Height	33.0 mm
Mounting hole spacing, length	203.0 mm
Cable cross-section, input side	0.75...2.5 mm ²
Cable cross-section, output side	0.75...2.5 mm ²
Wire preparation length, input side	10...11 mm
Wire preparation length, output side	10...11 mm
Product weight	420.00 g

Colors & materials

Casing material	Plastic
-----------------	---------

Temperatures & operating conditions

Ambient temperature range	-25...+50 °C
Maximum temperature at tc test point	75 °C

Lifespan

ECG lifetime	40000 h ¹⁾
--------------	-----------------------

¹⁾ At maximum T_c / 10% failure rate

Additional product data

Design / version	With cable clamp
Suitable for lamp power (1 lamp)	150 W

Capabilities

Max. cable length to lamp/LED module	1.5 m
Overheating protection	Power reduction and switch off at T > 75 °C at the tc point
ECG reset time	> 0.5 s
Cable/wire types, input side	NYM-J 3x1.5 / NYM-J 3x2.5 / H05VV-F 3x1.5 / NHXMH-J 3x1.5 mm ²
Cable/wire types, output side	SIHF-J 3x1.5 / SIHF-J 3x2.5 / SIHSI 3x1.0 mm ²
Dimmable	No
Restriction on ignition time	20 min
Suitable for fixtures with prot. class	I
Intended for no-load operation	No

Certificates & standards

Approval marks – approval	ENEC 10 / VDE / VDE-EMC / EAC / C-Tick
Type of protection	IP20

Product datasheet

EEI – Energy Label	A2
Standards	Acc. to EN 61347-2-12/Acc. to EN 55015/Acc. to EN 61000-3-2/Acc. to EN 61547/Acc. to EN 61347-2-12/Acc. to EN 62493

Logistical data

Commodity code	850410809000
----------------	--------------

Environmental information

Information according Art. 33 of EU Regulation (EC) 1907/2006 (REACH)	
Date of Declaration	14-04-2022
Primary Article Identifier	4008321915535
Candidate List Substance 1	Lead
CAS No. of substance 1	7439-92-1
Safe Use Instruction	The identification of the Candidate List substance is sufficient to allow safe use of the article.
Declaration No. in SCIP database	9e2486c9-8810-436a-a601-8812c30eb808

Wiring Diagram

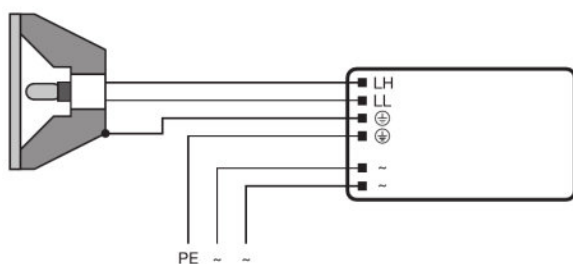

342376_Downlight Setup

Product datasheet

Safety advice

Ballast losses and lamp heat radiation can lead to heat accumulation in a completely closed case. Therefore it is necessary to ensure that the temperature at the measuring point t of the ECG does not exceed the maximum value.













Attention!

For safety reasons disconnect the device before replacing the lamp!

Additional product information

- In order to achieve good radio interference suppression:1. Keep the cable between ECG and lamp as short as possible.2. The single lamp wires must be routed as close as possible to each other.
-

Download Data

File	
	User instruction POWERTRONIC PTi PT FIT I
	Tender documents 339884_Tender Document for POWERTRONIC EVG.eng
	Certificates 554891_EAC PT family
	Certificates VDE ENEC Certificate 40035813
	Declarations of conformity Powertronic UK DoC 4278196 150222
	Declarations of conformity Powertronic CE 3363432 150222
	Declarations of conformity VD EMC Certificate 40025469
	Operating instructions 590731_EAC - PTi PT-FIT I
	CAD data 3-dim 315659_PTi 100150 9900048
	CAD data 3-dim 315660_PTi 100150 9900048
	CAD data 3-dim 315661_PTi 100150 9900048
	CAD data PDF 315656_PTi 100150 9900048

Product datasheet

Ecodesign regulation information:

Separate control gear and light sources must be disposed of at certified disposal companies in accordance with Directive 2012/19/EU (WEEE) in the EU and with Waste Electrical and Electronic Equipment (WEEE) Regulations 2013 in the UK. For this purpose, collection points for recycling centres and take-back systems (CRSO) are available from retailers or private disposal companies, which accept separate control gear and light sources free of charge. In this way, raw materials are conserved and materials are recycled.

Logistical Data

Product code	Product description	Packaging unit (Pieces/Unit)	Dimensions (length x width x height)	Volume	Gross weight
4008321915535	PTi 150/220...240 I	Shipping carton box 20	488 mm x 100 mm x 453 mm	22.11 dm ³	9440.00 g

The mentioned product code describes the smallest quantity unit which can be ordered. One shipping unit can contain one or more single products. When placing an order, for the quantity please enter single or multiples of a shipping unit.

Disclaimer

Subject to change without notice. Errors and omission excepted. Always make sure to use the most recent release.

PTi 150/220...240 I

POWERTRONIC INTELLIGENT PTi I | ECG for HID lamps, with cable clamp

Product name	Lamp group
PTi 150/220...240 I	HCI-E/P 150W
	HCI-TS 150W
	HQI-R 150W
	HQI-T 150W
	HQI-TS 150W